



General

Präambel SV

Helper Regulations

BH

Phase A

Phase B

Phase C

Additional examinations IGP-ZTP

Additional examinations IGP-V

Additional examinations FPr 1-3; UPr 1-3; SPr 1-3

Article Indication Trial 1-3

Endurance test (IAD)

Endurance test SV - AD

Diagrams

Upon presentation on the occasion of seminars or training courses the authors are to be quoted and copy rights are to be observed. Copies may only be distributed (also in excerpts) after having obtained the author's permission.



Preamble FCI

Purpose information

Trial Season / Trial Days

Trial Organization / Trial Secretary (PL)

Trial Supervision

Trial Judges (LR)

Permission to enter a trial

Further Trial permission

Anti-doping and vaccination regulations

Social compatibility

Phases per day per Trial level

Trial Participants

Physically challenged handler (handicapped)

Collar requirement / Carrying a leash

Muzzle obligation

Liability

Vaccinations

Awards Ceremony / trophies

Working Title

Scorebook

TSB Evaluation – Phase “C” (valid for all trial levels)

Commands

International Rules / Special rules

The precursor to the IGP (IGP - V) may be used

World /Europe Championship

Results of the temperament test

Disciplinary rights

Borderline = requires special attention

Disqualification

Dogs that may not participate in the trial

Reason for disqualification

Conducting the identity check

Termination

Dogs that do not show gun-sureness

Reasons for termination

Evaluation

Termination due to illness /
injury

Point table

Temperament Evaluation

Point table - Individual tests



DASHBOARD – IGP 2019

GENERAL REGULATIONS FOR HELPER

Dashboard

Egon Gutknecht

Pre-requisites for employment as a helper in Phase “C”

Purpose Regulations governing the conduct of trial helpers

Bark and Hold

Prevention of an attempted escape of the helper

Defense against an attack during the guarding phase

Back transport (Trial levels IGP 2 + IGP 3)

End Back Transport (trial level IGP 2)”

Attack on the dog out of the back transport (Trial level IGP 3)

Attack on the dog out of motion
IGP-1 : 30 Meter, IGP-2: 40 Meter, IGP-3: 50 Meter

Termination of the defence exercise

Insecurities and failure of the dog



I
G
P

2
0
1
9

Companion Dog test with traffic safety part BH-VT

Examination description: Companion dog test with traffic safety part BH-VT

General Information Examination in traffic

Examination procedures
(The following exercises represent a minimum requirement and can be extended by the national organizations). Encounter with group of persons

Encounter with Bicyclists

Encounter with Cars

Encounter with joggers or inline skaters

Encounter with other dogs

Behaviour of the tethered dog, which is left alone in the short term and behaviour towards animals



Phase A – Tracking: General Rules IGP 1-3, IFH-V, IFH-1, IFH-2, IGP-FH

Purpose Rules IGP-V and IGP-ZTP Tracks

Instruction: Only IFH 1, IFH 2 , and IGP FH

Instruction: Only IFH-2 and IGP-FH

Tracking Grounds

Laying the Tracks

Articles

Indicating

Pick up / Retrieve

Track with a tracking line

Free Tracking

Report in / Report out



Working the Track

Only IFH-1 / IFH-2 / IGP-FH

Corners

Praise

Termination / Disqualification

Further evaluation criteria / responsibilities of the Judge (LR)

Deductions for all examination levels

Purpose Provisions

Commands

Distribution and Point values of the exercises in the individual levels
IGP 1 - 3

Distribution and Point values of the exercises in the individual levels
IBGH 1-3

Specialties in IBGH 1 - 3

Specialties in IBGH 3

Exercises in IGP-V and IGP-ZTP

Note

Start and end of an exercise

Basic Position

Build-up

Pick Up

Recall / Front / Finish

Praise

Incorrect Positions



Releasing the Dumbbell upon command

Dumbbell

Hurdle

Scaling Wall

Exercise descriptions Phase B

DASHBOARD – IGP 2019 – ABTEILUNG B – DESCRIPTION/EVALUATION

[Zurück](#)

[Dashboard](#)

Egon Gutknecht

Heeling on Leash and Free Heeling

Heeling Pattern Diagram

Execution Heeling on Leash and Free Heeling

Evaluation criteria on Heeling on Leash and Free Heeling

Execution Sit out of Motion (all examination levels)

Evaluation criteria on Sit out of Motion

Execution down with Recall

Evaluation criteria on Down with Recall

Execution stand while Walking IGP-2 and IBGH-3

Evaluation criteria Stand while Walking

Execution stand out of Motion (IGP-3 only)

Evaluation criteria Stand out of Motion

Execution retrieve on the Flat

Evaluation criterial Retrieve on the Flat

Execution basic Position in Front of the Hurdle and scaling wall

Retrieve over the 1m hurdle



Evaluation criteria Retrieve over the 1m hurdle IGP 1 – IGP 3

Climbing over the scaling wall (IGP-1 only)

Evaluation criteria Climbing over the scaling wall (IGP-1 only)

Retrieve over the scaling wall

Evaluation criteria Retrieve over the scaling wall

Execution send out with Down

Evaluation criteria Send out with Down

Execution down under Distraction

Evaluation criterial Down under Distraction

Praise

Mandatory Deductions

DASHBOARD – IGP 2019 – PHASE C

- DESCRIPTION/EVALUATION

Dashboard

Egon Gutknecht



IGP
2019

Phase C - Protection (IGP 1-3): Purpose Provisions

Field Markings

Blinds

Basic requirements TSB

Rating table

Extra Commands – Deductions

Examination Levels IGP-1 to IGP-3 (Exercises and Points Values)

Report in

Search for the helper

Description search for the Helper IGP 1,2,3 (table)

Evaluation criteria Search for the helper

Hold and Bark (10 points for Hold and 5 points for Barking)

Evaluation criteria Hold and Bark

Evaluation criteria Hold and Bark (table)

Prevention of an attempted escape of the helper

Prevention of an attempted escape of the helper IGP 1

Prevention of an attempted escape of the helper IGP 2 - 3

Attempted Escape (IGP-1 – IGP-3)

Evaluation criteria attempted Escape (IGP-1 – IGP-3)

Defense of an attack from the guarding phase (IGP-1 – IGP-3)

End of the exercise IGP-1

End of the exercise IGP-2 u. 3

Evaluation criteria (IGP-1 – IGP-3)

Back Transport IGP-2

Back transport IGP-3

Back transport - Evaluation criteria

Attack on the dog from the Back Transport. IGP-3 only

Evaluation criteria back Transport (IGP-3 only)

Attack on the dog out of Motion

Attack on the dog out of Motion IGP 1

Attack on the dog out of Motion IGP 2

Attack on the dog out of Motion IGP 3

Evaluation criteria Attack on the dog out of Motion (IGP-1-3)

Defense of an attack from the guarding phase, with completion of phase C IGP-2 and IGP-3

Evaluation criteria

IGP-ZTP

Purpose information

Hold and Bark

Heeling and attack on the Handler HF

Transport to the Judge (LR)



IGP V

Prerequisite

Conditions

General provisions

Hold and Bark

Prevention of Attempted Escape

Attack on the Handler and his dog

Transport to the judge (LR)



DASHBOARD – FPR, UPR, SPR

Dashboard

Egon Gutknecht

Tracking 1 – 3 (FPr 1 – 3)

Obedience 1 – 3 (UPr 1 – 3)

Protection 1 – 3 (SPr 1 – 3)

Working dog test GPr 1 bis GPr 3 (GPr 1-3)



I
G
P

2
0
1
9

Article Indication Trial 1 – 3 (StPr 1 – 3)

General Requirements

Type of area for the Indication Work

Articles

Deploying the dog to locate

Behaviour at the articles

Rating

The evaluation criteria for all 3 levels

Positive criteria

Faulty is

Indication Area 1 - 3



Purpose

Admission of dogs

Rating

Terrain

Performance of endurance test

Running exercise



Purpose

Admission of dogs

Rating

Terrain

Performance of endurance test

Running exercise



Track shapes IGP-1 and IGP-2

Track shapes IGP- 3

Possible tracks for IFH-V

Possible tracks for IFH-1

Possible tracks for IFH-2 und IGP-FH

Corner

Laying the article

Sharp angle/cross Track

Blind Search

Setup for Prevention of an Escape

Hurdle

Scaling wall

Dumbbells



Präambel des SV

Leistungsrichter / Kostenabrechnung

Leistungsrichter / Höchstgrenze Prüfungen

Richten in der eigenen Ortsgruppe

Ausfall einer Veranstaltung/Reduzierung der Prüfungstage

Vorbereitung der Prüfung/Beginn der Prüfung/Fährtengelände

Geräte

Beginn der Prüfung

Bewertungslisten

Begleithundeprüfung mit Verhaltenstest(BH/VT)

Mindestteilnehmerzahl/Prüfungsteilnehmer/Mitgliedschaft/
Deckakt

DH- Prüfungen

SVAD-Prüfungen



Sozialunverträglichkeit

Videoaufnahmen

Überregionale Veranstaltungen



Preamble

For more than 35.000 years, the dog has been the companion of mankind. Through the domestication of the dog, a close social relationship was formed with mankind and is in some respects dependent on him. With this comes a certain responsibility on the part of man to ensure the well-being of the dog.

When it comes to training the physical as well as the psychological health of the dog is top priority. It is imperative then that the dog be handled in a fair, orderly and humane way. This also should include adequate care of the dog through proper nutrition and water as well as maintaining his health which needs to include regular vaccinations and veterinary examinations. In addition to this there is an additional duty to the dog to properly socialize him and to ensure exercise to meets his needs.

During the course of history, the dog has had various jobs to help man. In the modern day world, many of these duties have been relegated to technology. For this reason, the dog owner has the responsibility to ensure that the dog has other activities due to the loss of past jobs as well as adequate exercise and activities that offer close contact to people. Under this point of view the Companion Test – BH - , the versatility test for the utility dog, the tracking test – FH – and the article search test – StPr – need to be factored in. The dog should be occupied according to his abilities and capabilities. Besides adequate exercise, he should have intense work with activities that take into consideration his learning ability, his exercise requirements as well as his other abilities. The various forms of the dog sport provide these excellent venues. Dogs that do not have enough activities stand out and this can lead to public complaints. A person who trains or does sport with his dog, has to undertake a method of careful training with the goal in mind to achieve the best possible harmony between himself and the dog. The goal of all training is to convey to the dog what it is we want him to do in such a way that he can understand. The harmonious relationship between man and his dog, regardless of the dog sport one does, is the basis for all activities. To achieve harmony, it is important to honestly look at your dog and understand his abilities.

It remains the ethical responsibility of man to raise and adequately train the dog. The applied methods must meet the standards of behavioural sciences, especially in regard to the breed. In order to achieve the upbringing, training or training effect, it is important to not utilize force and to use positive methods for the dog. Furthermore, it is imperative to decline the use of techniques that do not utilize the proper training, raising and training aides. Using a dog for dog sport has to be oriented to his capabilities, his competitive spirit and his willingness. Influencing the dogs training capabilities through the use of medication or animal cruelty must be avoided. One must carefully acknowledge the capabilities of his dog. To demand work of a dog that does not have the capability to do so, contradicts every ethical level of consciousness. Only someone who takes the responsibility to be a true friend to his dog will take a healthy and capable dog to trials, competitions and training.



[Zurück](#)

[Dashboard](#)

Trial events and competition should serve two purposes.

- 1. After passing a test, the individual dog should receive recognition for its' particular purpose.**
- 2. Contribute to the overall health, fitness and work ethic of the dog.**

The National Organization (LAO) is encouraged to promote the International Utility Dogs Regulations. (IGP) Especially international competitions should be conducted under the International Utility Dogs Regulations concept. All trials and competitions are subject to proper sportsmanship with regard to the conduct of the participants. These regulations are binding. All participants have to meet the same work performance requirements. The trials are to be made public by advising the place and start time to the members.

Trial events and competitions must correspond with complete trial levels or individual complete phases of the respective trial levels. Only a completed trial level passed in an event will count as a title. The titles must be accepted by all FCI member countries.

Every trial level can be repeated as much as wanted. The trial levels must be completed in order (Level 1 – 2 – 3) The dog can only be shown in the next level after successfully passing the previous level with a minimum rating of satisfactory in each phase. The dog must be shown in the highest passed level. Exception, when there is no ranking or qualification “repeater” is connected to the trial.



Trial Season / Trial Days

[Zurück](#)[Dashboard](#)

Trial Season:

Trials may be conducted year round if weather conditions are conducive and the well-being of both handler and dog are not at risk. Otherwise, the event cannot be held. This is the sole decision made by the trial judge (LR). The individual national organization can impose restrictions regarding the trial season for their area.

Trial Days:

a) Saturday, Sunday and Holidays

Trial days are generally on the weekend as well as legal Holidays. BH/VT tests can also only be done on official trial days.

It is possible to trial for the BH/VT and the IGP-1/IFH-1 tests in tandem with a two day trial (Friday-Saturday), (Saturday-Sunday) at one or 2 different clubs. A waiting time between the BH/VT and IGP-1, IGP-V, FPr, UPr, SPr, AD, IFH-V, IFH-1, IGP-FH, IGP-ZTP, IBGH-1, StbPr. 1 does not exist.

Example: Friday Saturday BH, Sunday Saturday IGP-1 or IFH-1

b) Friday Trials

A Friday trial day may only be in tandem with a Saturday trial.

Remark: Friday can only be secured with Saturday if more dogs are presented on Saturday than can be accommodated. Start time is not before 12:00 noon. The participant number for the IGP/IFH is condensed to half. For pure BH/VT trials up to 7 dogs may be tested.

A Friday trial in tandem with a Saturday trial secured for IGP/IFH tests must end on Saturday. Individual dogs may also complete their trial on Friday.

Exception: If participants, who plan on trailing their dogs for IGP-1 or IFH-1 on Saturday / may start on Friday for the BH/VT and then on Saturday they may test for IGP-1 or IFH-1. This may not cause “overage” in the number of participants. Clubs must be attentive to the event authorization guidelines.

c) Holiday regulations

On Holidays the above information can be followed. Exception: The holiday regulations of the countries must be acknowledged. Half days before a Holiday during the week are not allowed to use.



Trial Organization / Trial Secretary (PL)

[zurück](#)[Dashboard](#)

The Trial Secretary (PL) is responsible to organize the event. He/she finalizes and supervises all required levels of work to prepare and conduct a trial. He/she must guarantee the orderly execution of the event and must be at the judge's disposal for the duration of the event.

The Trial Secretary (PL) may not show a dog or accept other duties. He/she is responsible for:

- **Obtaining the necessary event documents**
- **Locating suitable tracking fields for all trial levels according to the rules**
- **Make arrangements with the property owners of the tracking fields or park ranger**
- **Having experienced volunteers available such as helpers for protection, tracklayers, group, etc.**
- **Obtaining the event authorization**
- **Make available the required equipment and proper protection gear for the helper.**
- **Make available the written forms such as judges trial sheets, trial lists for all levels.**
- **Have available the scorebooks, pedigrees, vaccination certificates and if necessary proof of insurance.**

A minimum of three days in advance, the Trial Secretary (PL) must inform the judge (LR) the location, start times, directions, type of trial and number of dogs entered. Failure to provide this information can result in the judge (LR) declining to officiate.

The event authorization is to be provided to the judge (LR) prior to the start of the trial.

Trial Supervision

Egon Gutknecht



[Zurück](#)

[Dashboard](#)

National Organizations (LAO) of the FCI are entitled to supervise. The National Organization (LAO) of the FCI can assign a knowledgeable person to oversee an event to ensure that the event is conducted in accordance with the regulations as stated in the 2019 FCI IGP Regulations.

Trial Judges (LR)

Egon Gutknecht



[Zurück](#)

[Dashboard](#)

Judges (LR), who are authorized to judge an International Utility Dogs trial/ event, can be invited by the hosting club or as determined by the National Organization (LAO). In regards to world championships, the judges (LR) will be requested through the FCI Utility Dogs Commission. The number of judges (LR) invited for a trial is up to the hosting club. Trial judges (LR) are not permitted to judge dogs that are owned by him or are in his possession, or dogs whose owners reside with him, or dogs that are owned by another person of the same household.

A trial judge is not permitted to handle a dog in a trial in which he is officiating as a judge.

The trial judge (LR) is not permitted to disturb or influence the work of the dog through his behaviour. The trial judge (LR) is responsible for the compliance and correct adherence to the governing rules. He is authorized to terminate the trial for failure of compliance of the rules and/or his instructions. In such cases, the judge must provide a written report to the appropriate office of the National Organization.

The trial judge (LR) is authorized to disqualify a handler in the event of unsportsmanlike behaviour, carrying of motivational articles, non-compliance with the rules, non-compliance with animal rights guidelines, and anything against the local laws. A premature termination of a trial must be documented in the scorebook. In the event of a disqualification all acquired points will not be recognized.

The judge's decision is final and incontestable. Any form of criticism concerning the decision, can lead to dismissal from the site and eventually lead to disciplinary measures. In justified cases, not based on factual decisions, rather violations of the rules by the judge (LR), a complaint may be submitted within 8 days of the occurrence. This complaint must be made in writing, whereby the plaintiff and at least one witness signs it and submits it via the trial secretary of the hosting club or the national organization (LAO). Filing a complaint does not automatically lead to a dismissal of the judge (LR)'s decision. The decision concerning a complaint affects the National Committee, who can submit the claim to the FCI Utility Dogs Commission and makes the final determination regarding the complaint.



Permission to enter a trial

[Zurück](#)
[Dashboard](#)

On the day of testing, the dog must have met the minimum age required. No exceptions are permitted. The dog is required to have passed the BH-VT in accordance with the rules set forth by the national organisation (LAO).

The required age limit for BH/VT is to be set by the national organisation, but never can be under 12 months of age.

	Needed	Minimum Age
IBGH-1	BH-VT	15 Months
IBGH-2	IBGH-1	15 Months
IBGH-3	IBGH-2 or Obedience 1 or IGP-1	15 Months
IGP-V	BH-VT	15 Months
IGP-1	BH-VT	18 Months
IGP-2	IGP-1	19 Months
IGP-3	IGP-2	20 Months
IFH-V	BH-VT	15 Months
IFH-1	BH-VT	18 Months
IFH-2	IFH-1	19 Months
IGP-FH	BH-VT	20 Months
IGP-ZTP	BH-VT	18 Months
F.Pr. 1-3	BH-VT	15 Months
U.Pr. 1-3	BH-VT	15 Months
G.Pr.1-3	BH/VT	15 Months
SPr. 1-3	BH-VT	18 Months
Stö.Pr. 1	BH-VT	15 Months
Stö.Pr. 2	Stö.Pr. 1	15 Months
Stö.Pr. 3	Stö.Pr. 2	15 Months
IAD	BH-VT	16 Months

Further permission to enter a trial

Egon Gutknecht



[Zurück](#)

[Dashboard](#)

The exercises FPr 1-3 take place according to the IGP 1-3 Rules for Phase A, the exercises UPr 1-3 take place according to the IGP 1-3 Rules for Phase B, the exercises SPr 1-3 take place according to the IGP Rules for Phase C. The exercises Gpr 1-3 take place according to the IGP 1-3 Obedience and protection Rules for Phase B&C

These exercises can be tested as single phases, without getting any official certificate (working title). Trials with only a protection phase are not permitted.

The dog handler can chose in which level of these trials he/she will start without a previously passed lower level. Dogs regardless of size, breed or heritage may participate at a trial. The dog must be in physical condition to complete the requirements of the IGP.

Females in heat may participate at all trial events, however, must be shown separately from the other handlers' dogs. In phase A, they will track with the other dogs entered in the trial, but in the remaining phase / phases they will be shown at the end after all other dogs have completed the trial. Females, who are visibly pregnant or who are nursing or who have puppies with them, may not be trialed.

Sick and dogs suspected of contagious disease are excluded from all trial events. In case of doubt, the veterinarian will make the final decision. A separate publication of the FCI and / or the national organization provides information on restricted periods for pregnant and lactating bitches.

Anti-doping and vaccination regulations

Egon Gutknecht



[Zurück](#)

[Dashboard](#)

A dog registered by his owner for participation in a competition and placed by him or the dog handler in the test ground must be clear of all drugs in his tissues, his body fluids and his excretions on the day of the event to include all substances which are listed on the banned substance list of the FCI.

The list of substances, the procedure for the testing for banned substances, and the possible penalties for infringements are published in a corresponding set of rules of FCI. National organizations can extend these provisions by their own responsibility. The dog must have a rabies vaccination proven by a vaccination certificate.



[Zurück](#)

[Dashboard](#)

A dog who, at any time during the competition (before, during or after his own performance) bites a person or a other dog, tries to bite, attack or attempt to attack, is disqualified from the competition. All points are withdrawn and the dog is disqualified (DQ), even if the dog has completed all 3 phases. In a two-day event, the disqualification also extends to the second day so that the dog cannot start or continue in the trial.

In cases of dog aggression, immediate disqualification (DQ) occurs. Before the dog may enter another trial, the dog owners / handler have to prove during an examination or at a competition that the team (dog) has again successfully participated in a BH-VT with behaviour test. The disqualification shall be entered by the performance judge in all the performance records / score books, pedigree known to him and signed by him.

Entry: "Disqualification due to dog aggression, dog must be presented again in a BH-VT with behavioural test."



Phases per day per Trial level

[Zurück](#)

[Dashboard](#)

FPr, UPr and SPr, 1-3	equivalent to 1 phase``
GPr 1-3	equivalent to 2 phases
IBGH 1-3	equivalent to 1 phase
IFH-V / Tracking suitability	equivalent to 1 phase
IFH-1, IFH-2 and IGP-FH	equivalent to 3 phases
Begleithundeprüfung (BH-VT) / Companion examination	equivalent to 2 phases
IGP-Vorprüfung (V) / IGP- Suitability	equivalent to 2 phases
IGP- Zuchtauglichkeitsprüfung (ZTP) /IGP Breed suitability	equivalent to 3 phases
IGP 1 - 3	equivalent to 3 phases
Stöberprüfungen 1-3 / Article search 1-3	equivalent to 1 phase
Endurance Test	equivalent to 1 phase

For major events scheduled by the National Organization (LAO), special regulations can be established. The national organization (LAO) submits a proposal to the FCI Utility Dogs Commission, who makes the final determination.

Trial Participants

Egon Gutknecht



[Zurück](#)

[Dashboard](#)

The trial participant must meet the entry deadline for the event. The participant also agrees to pay the entry fee upon submission of the entry form. If the participant cannot participate for whatever reason, he/she must advise the Trial Secretary (PL) immediately. The participant is required to provide the vaccination certificate and uphold the animal rights guidelines. The participant must adhere to the instructions of the judge (LR) as well as the Trial Secretary (LR). The handler must present his/her dog in a sportsmanlike manner regardless of the results in any given phase, he is obliged to continue for the remaining phases of the event. The trial ends with the results (awards ceremony) and the return of the scorebook. The examination (trial) must have a minimum of 4 participants per trial day. The minimum number of participants per day may only be less if for BH / VT examinations these dogs pass and try for a further examination (IGP-1, IFH 1) at the same event. A dog handler may only take part in an examination with the same dog. (A two-day test is considered as an examination event.) A dog handler may enter a maximum of two dogs for an examination at an event. A dog may only acquire one title within a event. Exception: BH / VT in conjunction with another level 1 title. Prerequisite for entering a trial is that owner and dog handler belong to a club of the national organization which is recognized by the FCI. Exceptions to this can be determined by the national organization only for BH / VT examinations.



Physically challenged handler (handicapped)

[Zurück](#)[Dashboard](#)

If a dog handler cannot carry out part of an exercise correctly due to a physical handicap, he must inform the performance judge (LR) before the start of the trial. If due to a physical handicap the dog handler can not present the dog on the left side of the dog handler, the dog may be presented in the same way on the right side. The national organizations may also allow further restrictions.



Collar requirement / Carrying a leash

[Zurück](#)[Dashboard](#)

The single row, loose fitting large link collar must be worn throughout the trial. The BH / VT allows the use of other types of collars to include leather collar, fabric collar or chest harness. For the IBGH 1 to 3, similar collars to the BH / VT may be used except for the chest harness. For the tracking phase, a dog may wear a tracking harness or a vest in addition to the required loose fitting large link collar.

A leash must be carried for the duration of the trial. It may be out of sight or worn by the handler with the clip on the side opposite to the dog's working side.

Muzzle obligation

Egon Gutknecht



[Zurück](#)

[Dashboard](#)

The requirements for having a dog in public are mandated by the laws of the individual countries laws. Handlers (HF), who are bound by these laws, may show their dogs in the BH/VT test with a muzzled dog.

Liability

Egon Gutknecht



[Zurück](#)

[Dashboard](#)

The owner of the dog is liable for any personal injury or material damage caused by his/her dog. Therefore, he/she must have adequate coverage for such cases. In the event of an accident during the trial, the handler (HF) is liable for himself/herself and his/her dog. The handler (HF) is to concur with the instructions of the judge (LR) and the organizing club and thereby executes of his/her own free will the instructions at his/her own risk.

Vaccinations

Egon Gutknecht



[Zurück](#)

[Dashboard](#)

Proof of vaccinations as performed by a certified authority (vaccination certificate) must be presented to the judge (LR) or the Trial Secretary (PL).

Awards Ceremony / trophies

Egon Gutknecht



[Zurück](#)

[Dashboard](#)

Award ceremonies are to be held separately after the various trial phases.

If the same number of points are awarded to more dogs in the IGP level 1 -3 the result (highest score) of the phase C is the deciding factor. If the points awarded here are the same, then phase B is the deciding factor. If points result equally for all three phases, then all dogs receive the same rating. If the same number of points are awarded to more dogs in the IGP-FH, the result (highest score) in the single track is the deciding factor. If the points awarded in both tracks are the same, then all dogs receive the same rating.

Generally, all participants are to be present at the awards ceremony. The trial ends officially with the award ceremony and handing out of the scorebooks.



Working Title

[Zurück](#)[Dashboard](#)

The title “International Working Champion” (CIT) will be granted by the FCI by application of the handler (HF) through the National Organization (LAO).

The CACIT award and the Reserve CACIT for dogs are provided at competitions that have received permission from the FCI and for dogs which were presented at the highest level (Class 3). All FCI National Organizations (LAO) must be invited to a CACIT event. A minimum of 2 judges (LR) must be invited with one judge being from another National Organization (LAO). The awards are granted upon proposal of the judges (LR). The CACIT and Reserve CACIT can only be awarded to dogs under these recommendations:

- The minimum show rating “very good” has been achieved at a show event.
- At the trial the minimum rating of “Very Good” was received. The award is not automatically linked to the achieved rating.
- The dog breeds belonging to groups 1, 2 and 3 of the Breeds Nomenclature of the FCI which are subject to a working trial (utility and tracking dogs)

The title “National Working Champion” will be regulated through the National Organization (LAO). Per Trial there is only to be awarded one (1) CACIT and one (1) reserve CACIT

Scorebook

Egon Gutknecht



[Zurück](#)

[Dashboard](#)

A scorebook is mandatory for every participating dog. Issuing of the scorebook is done according to the instructions of the handler's corresponding National Organization. Important to note, only one scorebook may be issued per dog. This is the responsibility of the issuing organization. The trial results must be recorded in the scorebook under all circumstances by the judge (LR) as well as the Trial Secretary (PL), who is to double check the entry and sign the book.

It is required to make the following entries: Members number, name and breed of the dog, identification of the dog (tattoo nr. / Chip Nr.) Name and address of the owner of the dog, entry of the total points in Phase A, B and C, qualifications and TSB rating. Name of the judge and his signature.



TSB Evaluation – Phase “C” (valid for all trial levels)

[Zurück](#)[Dashboard](#)

The TSB evaluation should describe the temperament characteristics of the dog for breeding purposes. The TSB has not influence over the final result of the trial or a placing. To achieve a TSB evaluation, the dog must have been completed at least one gripping exercise.

The ratings pronounced (a), present (vh) and insufficient (ng), the following characteristics are described: Drive, self-confidence and stress-tolerance.

TSB – “pronounced”

Is given to a dog that displays a strong willingness to work, clear instinctive behaviour, goal-oriented determination in the exercises, self-confident manner, unrestricted attention and exceptional ability to handle stress.

TSB – “sufficient”

Is given to a dog that is restricted in his willingness to work, the instinctive behaviour, in self-confidence, his attention and stress tolerance.

TSB – “insufficient”

Is given to a dog that lacks a willingness to work, lacking instinctive behaviour, lacks self-confidence and insufficient stress-tolerance.

Commands

Egon Gutknecht



[Zurück](#)

[Dashboard](#)

The Commands in the examination regulations are considered suggestions. Commands are given as normal spoken words and must always be the same for the same task. When recalling the dog, the name of the dog can be used instead of the command to recall. During the blind search, the name of the dog can be mentioned in addition to the recall command. Otherwise, the name of the dog in conjunction with any other command is considered a double command.

The national organization may make provision for the use of only the national language commands, which are provided by the national organization and published in their rulebook. It is, however, permissible in any case that the commands may be given in the mother tongue of the dog handler.

International Rules / Special rules

Egon Gutknecht



[Zurück](#)

[Dashboard](#)

The national organizations (NAOs) of the FCI are authorized to enhance their general regulations, e.g. entry requirements, veterinarian, animal rights, medical regulations or any rules governed through the country. Commands may be given in the country's language.



The precursor to the IGP (IGP - V) may be used

[Zurück](#)

[Dashboard](#)

1. As an approval test for the declaration in the working class.
2. As a condition for admission to IGP-1, whereby each country's organization can decide whether the IGP-V is required as a prerequisite to enter for IGP-1.

World / Europe Championship

Egon Gutknecht



[Zurück](#)

[Dashboard](#)

The Specifications for the organization of the various championships of the FCI are valid. The publishing and revision of said specifications are the duty of the Utility Dogs Commission.

Disciplinary rights

Egon Gutknecht



[Zurück](#)

[Dashboard](#)

The Trial Secretary is responsible to guarantee order and the safety in the entire trial area.

The judge (LR) is authorized to terminate the trial if the order and safety is compromised in any way. Violations by the handler against the prevailing rules, against the trial rules, against the animal rights laws and against the cultural customs will lead to a termination of the trial.

The trial judge's assessments of the performance are final and may not be contested. Public criticism of a judge's assessments may result in dismissal from the trial grounds and further disciplinary action may follow. Justifiable objections may be made in cases where the judge has violated the trial regulations but not against his assessments. Any such objections must be made in writing and addressed to the relevant authority and must be lodged with the show holding organization and signed by the complainant.

Objections must be lodged within 8 days of the close of the trial. Acceptance of an objection does not imply that the judge's assessment will be revised. Video recordings for evidential purposes are not permitted. The provisions of the disciplinary regulations of the national organizations must be taken into account.

Disqualification

Egon Gutknecht



[Zurück](#)

[Dashboard](#)

All points awarded up to that point of disqualification (DQ) will be deleted. No points or ratings will be entered into the scorebook. There will not be an evaluation. It is not permitted to show the dog in the other phases. In the scorebook the reason for the disqualification has to be written by the judge.



Reason for disqualification

[Zurück](#)

[Dashboard](#)

Reason for disqualification	Consequence
<ul style="list-style-type: none"> • Dog picks up the article on the track and will not or can not release it • Dog chase game and will not track anymore • The dog leaves the field and does not return after three commands to return • The dog is not under control of the handler (e.g., side / back transport); The dog does not become under control after three commands HZ (one allowed and two additional HZ) or only by active action of the Handler • The dog bites (not bumps) the helper anywhere on the helper's body other than the protective sleeve provided for the grip. • Dog is in defence targetting an other person (Judge, Steward etc.) than the helper. 	<p>Disqualification for disobedience</p>
<ul style="list-style-type: none"> • The dog is not neutral during the impartiality check 	<p>Disqualification due to lack of impartiality</p>
<ul style="list-style-type: none"> • Unsportsmanlike behaviour of the Handler HF (for example, transport of motivation objects and / or food) • Act against the IGP, animal protection or contrary to good manners Suspected attempt of fraudulent intent by use of prohibited training aids 	<p>Disqualification for unsportsmanlike behaviour</p>

Termination

Egon Gutknecht



[Zurück](#)

[Dashboard](#)

In the case of a termination, all points awarded up to then are awarded, also the points of the phases that have been completed so far. The points reached up to the point of termination are entered in the scoreboard. If the dog is terminated in phase C, phase C is to be evaluated with 0 points, the points reached in sections A and B are retained.



Reasons for termination

[Zurück](#)[Dashboard](#)

- Dog is started on the track 3 x unsuccessfully in the scent pad
- Dog leaves track by more than one leash length or Handler (HF) disregards the Judge's (LR's) instruction to follow the dog
- Dog is not at the end of the track in the given time.
- The dog leaves the helper before the Judge (LR) instructs the Handler (HF) to leave the centre line and does not return to helper with one command or leaves the helper again.
- Dog fails in defence exercise.
- Dog leaves the helper before the Judges (LR) instruction to approach the dog and / or the dog handler gives a command to make the dog remain (stay) with the helper

The dog does not find the helper after three unsuccessful commands to direct the dog to the find blind.



Termination due to illness/injury

[Zurück](#)[Dashboard](#)

If a dog presented for a trial is sick, this is to be handled in the following manner:

If the handler (HF) reports in after having completed a phase with a sick dog, he is to go to the vet and obtain a certificate. Entry in the trial documentation "Terminated due to illness". If the handler (HF) refuses to go to the vet, then the entry is to be shown as:

"Insufficient due to termination". The certification may be sent retro-actively. If the handler (HF) does not submit this certificate within 4 days, the judge (LR)'s entry in the scorebook remains as "Insufficient due to termination". The scorebook will be returned to the handler (HF). If the handler (HF) refuses to leave the scorebook with the judge (LR), then the entry "Insufficient due to termination" will be immediately recorded. The handler (HF) is responsible for any costs in connection with the return of his scorebook. Remark: it remains clear that the judge (LR) himself can decide to terminate if he determines that the dog is appearing sick or injured to him. The same applies to older dogs that due to animal rights laws may not be able to continue due to fitness. Entry in scorebook: "Termination due to injury".



Temperament Evaluation

[Zurück](#)[Dashboard](#)

The temperament test is to be conducted throughout the duration of the trial including the awards ceremony. If a dog stands out with a temperament problem, then he cannot pass for this reason even though results up to that point were positive. If a dog fails the temperament test it is to be noted in the records. The dog is disqualified (DQ).

1. The temperament test takes place prior to each trial.
2. The test is to be conducted in a neutral place. In the selection of the place, there should be no close connection to the trial or tracking fields.
3. Every dog is to be evaluated independently.
4. The time-frame should be such that the dog is not immediately to start tracking or go on the trial field.
5. The dogs are to be on leash (short leash – without tracking harness, etc.). The leash is to be held loose. The dog must be led under control.

Following rules are to be adhered to during the evaluation:

A systematic evaluation is not permitted, it is up to the judge to determine the way it is to be conducted, there are not to be extreme variations in the evaluation and the less a judge (LR) tries to make a point, the smoother and safer the test will run. The evaluation is to be done in a normal everyday setting, the dog is not to be challenged, as otherwise it would invoke a natural reaction, unnatural stimuli are to be avoided. The identity control is a mandatory part of the temperament test. The temperament test does not only take place at the beginning of the trial, but also during the entire event. If the judge determines a temperament weakness, he has to test it exactly (e.g. gun test). Repetitions are permitted to make a determination.

The BH / VT test does not have the gun shots test. A BH / VT test dog is not allowed to be paired with dogs from the IGP levels because of the gun shots. The BH / VT or IBGH may be paired together as a group. (BH / VT and IBGH-no gun shots)

Results of the temperament test

Positive presentation = passed

Dog is self-confident

Dog is calm, secure and attentive

Dog is lively and attentive

Dog is impartial and good-natured

Egon Gutknecht



[Zurück](#)

[Dashboard](#)

Borderline = requires special attention

Egon Gutknecht



[Zurück](#)

[Dashboard](#)

**Dog is unsteady but not aggressive and is balanced throughout the trial
Slightly agitated, but gets calmer throughout the trial**

Dogs that may not participate in the trial

Insecure and frightened, move away from a person
Nervous, aggressive, dogs sounding an alarm, fear biters.
Biting dogs

Egon Gutknecht



[Zurück](#)

[Dashboard](#)



Conducting the identity check

[Zurück](#)[Dashboard](#)

The identity control is a mandatory part of the test. This can be done by either checking the tattoo number or using a chip reader for a microchipped dog. Dogs that do not have a pedigree or a tattoo number, must be microchipped. The judges must note in their records that the identity check was carried out.

If tattoo numbers are not easily recognizable, those numbers that are need to be recorded. The tattoo number must coincide with the one entered on the pedigree. If difficulties arise (e.g. unable to read a number), then a remark must be made accordingly.

If chip numbers are not identified through the chip reader, then a remark must be recorded. The dog may compete if it is possible to determine that the dog was correctly chipped in that country (e.g. a corresponding remark is noted in the Registration, Passport or health certificate).

Handlers that had their dogs microchipped in a foreign country, or who have purchased a dog from another country, are responsible that the appropriate microchip reader is made available. Dogs that cannot be definitively identified may not participate in a trial / event.

If the microchip is not found by the judge, the judge instructs the dog handler to carry out the chip control himself. A subsequent check by the judge is then to be carried out again. It is mandatory that the performance judge check the dog with the chip reader.



Dogs that do not show gun-sureness

[Zurück](#)[Dashboard](#)

What is the understanding of the term “gun-shy? Examples: The dog gets up and shows fear and runs away The dog shows a fear reaction.

- **Runs under the same manner to his handler**
- **Shows panic and fear and tries to leave the area or leaves it**
- **Shows panic and fear and runs wildly around**

During the evaluation, it must be determined if the behaviour is due to a training fault or if his getting up is not related to the gun shot.

In dubious cases, the judge (LR) is responsible to determine if it is gun sensitivity by having the handler put the dog on leash. From a distance of about 15 paces, the judge (LR) will request additional shots be fired whereby the dog is to be held on a loose leash.

Evaluation

Egon Gutknecht



[Zurück](#)

[Dashboard](#)

The evaluation of the performance is noted with ratings (qualification) and points. The rating (qualification) and the corresponding points must reflect the quality of the respective exercise.

Point table



[Zurück](#)

[Dashboard](#)

Highest Points	Excellent	Very Good	Good	Satisfactory	Insufficient
5	5,0	4,5	4,0	3,5	3,0 - 0
10	10,0	9,5 – 9,0	8,5 – 8,0	7,5 – 7,0	6,5 – 0
15	15,0 – 14,5	14,0 – 13,5	13,0 – 12,0	11,5 – 10,5	10,0 - 0
20	20,0 – 19,5	19,0 – 18,0	17,5 – 16,0	15,5 – 14,0	13,5 - 0
30	30,0 – 29,0	28,5 – 27,0	26,5 – 24,0	23,5 – 21,0	20,5 - 0
35	35,0 – 33,0	32,5 – 31,5	31,0 – 28,0	27,5 – 24,5	24,0 - 0
60	60,0 – 58,0	57,5 – 54,0	53,5 – 48,0	47,5 – 42,0	41,5 - 0
70	70,0 – 66,5	66,0 – 63,0	62,5 – 56,0	55,5 – 49,0	48,5 – 0
100	100,0 – 96,0	95,5 – 90,0	89,5 – 80,0	79,5 – 70,0	69,5 – 0
200	200 – 192	191 – 180	179 – 160	159 – 140	139 – 0
300	300 - 286	285 - 270	269 – 240	239 – 210	209 - 0
Calculation of Percentage					
Evaluation	Awardet percentage	Deduction			
Excellent	= mindestens 96 %	oder bis minus 4 %			
Very Good	= 95 bis 90 %	oder minus 5 bis 10 %			
Good	= 89 bis 80 %	oder minus 11 bis 20 %			
Satisfactory	= 79 bis 70 %	oder minus 21 bis 30 %			
Insufficient	= unter 70 %	oder minus 31 bis 100 %			



Point table - Individual tests

[Zurück](#)[Dashboard](#)

During the evaluation of a particular phase only full points are to be awarded. However with individual exercises, partial points can be given. For final results if points are awarded with partial levels, then they can be either rounded up or down.

In order to be able to go on to the next higher level, the team must score a minimum of 70% of the maximum possible score.



Pre-requisites for employment as a helper in Phase “C”

[Zurück](#)[Dashboard](#)

1. The guidelines and regulations of the trial rules regarding help work must be followed.
2. The helper (HL) in phase “C” is the assistant to the judge on the day of the trial.
3. In view of his personal protection as well as due to insurance liability, the helper, whether in training or on a given trial day or competitions, must wear protective clothing, (protection pants, protection jacket, sleeve, cup, and if necessary gloves).
4. The helper (HL)’s shoes must be weather-proof and suitable for the ground conditions, secure stance and ensure good traction.
5. Prior to the trial work in phase “C”, the helper (HL) receives instructions from the judge (LR). He must perform the work in accordance to the judge’s instructions.
6. The helper (HL) must follow the instructions of the handler (HF) during disarming/search of the helper in accordance with the trial rules. He must give the handler (HF) the opportunity to position his dog in the correct heel position for the side/back transport.
7. The handler may work with the helper (HL) at club trials. If there are more than 6 dogs, then 2 helpers (HL) are required. For trials at a National level, such as competitions, qualification trails, championships, etc. generally 2 helpers (HL) are mandatory. For all or any of these trials, a helper (HL) living in the same household as one of the handlers (HF) may participate.

General Regulations governing the conduct of trial helpers

Egon Gutknecht



[Zurück](#)

[Dashboard](#)

1. During a trial the level of training, the quality of the dog being presented (e.g. his drives, stress-level, self-confidence and obedience) should be evaluated by the judge. The judge (LR) can objectively evaluate what he/she visually and acoustically observes during the course of the trial. This aspect, particularly maintaining the sportsmanlike character of the trial (i.e. this means offering the same conditions for all participants) ensures that the helper offers the judge (LR) a broad impartial picture to judge. Therefore, it cannot be left up to the helper (HL) how the phase “C” work is to be structured. Furthermore, the helper must follow definitive guidelines. The judge (LR) must check that the individual elements of the most important evaluation criteria for phase “C” are met. For example, these are, stress-level, self-confidence, drives, obedience. In addition it is important that the grip quality of the presented dog is properly evaluated. For the judge to properly evaluate the grip, the helper must give the dog the opportunity to have a “full grip”, and when the stress-level is to be tested, the helper must be able to put proper pressure on the dog. The helper must strive to have the most uniform level of helper work, so that the requirements of the evaluation are met.



Bark and Hold

[Zurück](#)[Dashboard](#)

2. The helper stance (position) standing – he should not be visible to the dog and handler – with a slightly angulated sleeve position motionless and without a threatening body position in the designated blind. The sleeve acts as body protection. At the hold and bark, the dog is to watch the helper, any motivation (help) on the part of the helper is not allowed. The soft stick is held at the helper's side.

PREVENTION OF AN ATTEMPTED ESCAPE OF THE HELPER

Egon Gutknecht



[Zurück](#)

[Dashboard](#)

3. After the hold and bark exercise, the handler calls the helper out of the blind, who is to exit in a normal pace and places himself/herself at the designated spot as assigned by the judge (marked spot). The position of the helper must ensure that the handler can place his dog at a distance of 5 paces on the side where the helper's protection sleeve is at the helper's designated spot. The flight path must be clearly recognizable for the handler.

Under the direction of the judge, the helper escapes in a quick and assertive pace in a straight line, without running an uncontrolled or exaggerated manner. The sleeve must remain steady and the dog should be given an optimal grip possibility. The helper may not turn to face the dog at any time, but can keep the dog in his/her field of vision. The helper must refrain from pulling the sleeve away. Once the dog has gripped, the helper continues to run in a straight direction, and while running pulls the sleeve in tight to his/her body.

The judge determines how far the helper needs to escape. Under the direction of the judge, the helper terminates the escape. When the corresponding dynamic work of the helper is carried out, it provides the judge with the optimal opportunity to evaluate the performance. Any type of helper assistance in the way of , excessive offering the sleeve before the grip, verbal agitation, or hitting the soft stick against his pants before or during the escape, limply held sleeve position, reducing the speed of the escape independent termination of the escape, etc., are not permitted. Stopping the exercise – see point 8 (valid for all exercises)

DEFENSE AGAINST AN ATTACK DURING THE GUARDING PHASE

Egon Gutknecht



[Zurück](#)

[Dashboard](#)

5. After the guarding phase, the helper makes an attack on the dog at the instructions of the judge. The soft stick is used in a threatening motion above the sleeve without hitting the dog. At the same moment, the dog grips in a frontal and forward movement with corresponding resistance / pressure, without the sleeve being moved to attract the dog. The protection sleeve will be carried tight and in front of the body with the bite bar available to ensure that the dog may get a opportunity for a correct grip. Once the dog has gripped, he is to be placed out of motion to the side and the pressure phase begins in a straight direction (drive). Turning / spinning at the start of the attack in this exercise is not permitted. The helper must drive all dogs in the same direction. It is important that the judge must place himself/herself in such a position so as to observe and evaluate the behaviour of the dog during the attack, the pressure phase, the grip behaviour, the out and the guarding phase. Driving the dog to the handler is not permitted.

The stick hit pressure tests are to be placed on the shoulder and in the area of the withers. The stick hits are to be executed with the same intensity for all dogs. The first stick hit test is performed after approximate 4 – 5 paces, the second stick hit test after an additional 4 – 5 paces during the pressure phase. After the second stick hit test, additional pressure is demonstrated without stick hits.

The duration of the pressure phase is determined by the judge. Under the direction of the judge, the helper terminates the pressure phase. When the corresponding dynamic work (drive) of the helper is carried out, it provides the judge with the optimal opportunity to evaluate the dog's performance, drive and temperament. Any assistance (help) given by the helper in the way of offering / attracting the dog the sleeve before the grip, verbal agitation, or hitting the soft stick against his pants before or during the escape, limply held sleeve position after the grip during the pressure phase, inconsistent intensity during the pressure phase and at the stick hits, independent termination by the helper when weakness is determined in the dog etc., are not permitted.

Termination of the exercise – see point 9

BACK TRANSPORT (TRIAL LEVELS IGP 2 + IGP 3)

Egon Gutknecht

[Zurück](#)[Dashboard](#)

5. Under the direction of the handler, the helper demonstrates a back transport over a distance of approximately 30 paces at a normal pace. The judge determines the course of the transport. The helper may not any sudden moves during the transport. The soft stick and the sleeve are to be carried in such a way that it does not stimulate the dog. The soft stick especially has to be carried out of sight. The helper is to move at the same normal walking pace for every dog.

END BACK TRANSPORT (TRIAL LEVEL IGP 2)

Egon Gutknecht

[Zurück](#)[Dashboard](#)

6.

At the order of the judge, the helper stops after approx. 30 paces. The dog handler goes to the helper and takes the Soft stick. The dog has to sit in the basic position. Then a side transport to the judge takes place.

ATTACK ON THE DOG OUT OF THE BACK TRANSPORT (TRIAL LEVEL IGP 3)

Egon Gutknecht



[Zurück](#)

[Dashboard](#)

7.

The attack out of the back transport is performed out of motion and under the direction of the judge. The helper performs the attack by making a dynamic left or right turn and running with purpose, presence and threat towards the dog. The soft stick is to be held above the sleeve and swung in a threatening motion. The dog has to be intercepted (caught) with a flexible position of the protection sleeve, to allow the helper to safely catch the dog without the need to come to a complete halt as long as the helper has the appropriate skill. Upon intercepting (catching) the dog, the helper should – if possible – turn in order to catch the dog to absorb the dog's momentum and flow with his body movement. Additional movement of the sleeve is to be avoided. Once the dog grips, the helper places the dog out of motion to the side and the pressure phase is conducted in a straight direction. The helper must drive all dogs in the same direction. It is important that the judge must place himself/herself in such a position so as to observe and evaluate the behaviour of the dog during the attack, the pressure phase, the grip behaviour, the out and the guarding phase. Driving the dog to the handler is not permitted.

The duration of the pressure phase is determined by the judge. Under the direction of the judge, the helper terminates the pressure phase. When the corresponding dynamic work (drive) of the helper is carried out, it provides the judge with the optimal opportunity to evaluate the performance. Any assistance given by the helper in the way of offering any assistance in the way of, offering the sleeve before the grip, verbal agitation, or hitting the soft stick against his pants before or during the escape, limply held sleeve position after the grip during the pressure phase, inconsistent intensity during the pressure phase and at the stick hits, independent termination by the helper when weakness is noticed in the dog etc., are not permitted. Termination of the exercise – see point 9.

**„ATTACK ON THE DOG OUT OF MOTION “
IGP-1 : 30 METER, IGP-2: 40 METER, IGP-3: 50 METER**

Egon Gutknecht



[Zurück](#)

[Dashboard](#)

8.

IGP-1: 30 meter, IGP-2: 40 meter, IGP-3: 50 meter

In IGP-1 and IGP-2, the helper remains where the 1st part was terminated. The dog handler is instructed to take the dog's starting point for this exercise.

In IGP-3, under the direction of the judge (LR), the helper leaves the assigned blind and moves at a running pace to the centreline without breaking stride and with threatening verbal and gestures attacks the dog and handler with a frontal attack with the soft stick.

The dog must be intercepted with the helper not stopping and presenting an approved trial sleeve. Upon intercepting the dog, the body should – if possible – turn in order to catch the dog and absorb the dogs flow to maintain the momentum. The helper may not in any way run around (side step) the dog. Once the dog grips, the helper places the dog out of motion to the side and the pressure phase is conducted in a straight direction. It is imperative to avoid overrunning (tripping over) the dog. The helper has to drive all dogs in the same direction. It is important that the judge must place himself/herself in such a position so as to observe and evaluate the behaviour of the dog during the attack, the pressure phase, the grip behaviour, the out and the guarding phase. Driving the dog back towards the handler is not permitted.

The duration of the pressure phase is determined by the judge (LR). Under the direction of the judge (LR), the helper terminates the pressure phase. When the corresponding dynamic work of the helper is carried out, it provides the judge with the optimal opportunity to evaluate the working performance and temperament of the dog. Any assistance given by the helper in the way of offering any type of helper assistance in the way of, slowing down the speed of the attack, intercepting the dog at a stand, side-stepping the dog before the grip, holding the sleeve in a limp fashion after the grip, varying intensity of the pressure phase, independent termination when weakness in the dog is noticed, etc. are not permitted.

TERMINATION OF THE DEFENCE EXERCISE

Egon Gutknecht



[Zurück](#)

[Dashboard](#)

9.

Stopping all defence exercises must be conducted in such a manner that the judge (LR) has the opportunity to observe the grip, the out and the guarding phase of the dog (do not turn your back to the judge (LR), maintain visual contact with the judge (LR)). Once stopping the defence exercise, the helper must minimize the resistance towards the dog, he/she has to reduce the stimulation by not definitively moving the sleeve. The sleeve is not to be carried at a high angle, but will be held in the same position during the previous exercise. The soft stick is held out of sight at the side. No help is to be provided by the helper during the out phase. After the out, the helper is to maintain eye contact with the dog, whereby any additional stimulation or help of any kind is not permitted. In order to maintain eye contact to the dog, the helper is allowed to turn for a dog that circles, but without any sudden movements.



INSECURITIES AND FAILURE OF THE DOG

[Zurück](#)[Dashboard](#)

10.

A dog that does not grip during a defense exercise, or releases the grip in a pressure phase and outs, must be driven (continued to be pressured) by the helper until the judge (LR) terminates the exercise. In such instances, the helper may not give any help to the dog or stop the exercise independently. Dogs that do not release, the helper may not use the soft stick in movement to get him to out. Dogs that have a tendency to leave the helper during the holding phase may not be stimulated by the helper to stay with the helper. In all or parts of any exercise the helper must present himself/herself active or neutral in accordance with the trial rules. If the dog bumps or grips during the holding phase, the helper must avoid making any defensive motions.



Companion Dog test with traffic safety part BH-VT

[Zurück](#)[Dashboard](#)

All dog owners who provide evidence that they have successfully passed the written examination if required by the regulations of the national organizations or those who have proof of a locally issued certificate. Dogs of all breeds and sizes are accepted. The minimum age of the dog is determined by the National Organization LAO, but may not be less than twelve months.

Dogs which do not reach the required 70% of the points in Part A ("Obedience") are not taken for examination in Part B ("Traffic Portion") The test was passed if 70% of the points to be reached in Part A and all exercises of part B were considered sufficient by the performance judge. It is up to the judge (LR), at the request of the hosting club, to place the participants at the awards' ceremony. The BH-VT is a prerequisite for entry into all further examinations. Each Examination result must be entered in the official trial paperwork and the scorebook regardless of the outcome of the examination.

**Examination description: Companion
Dog test with traffic safety part BH-VT**

Egon Gutknecht

[Zurück](#)[Dashboard](#)

The BH / VT test does not check the gun sureness of the dog.
Exercise requirements similar to the exercises described in the general part

Heeling on leash 15 Points

Heeling off leash 15 Points

Note: Special provision for BH-VT in the general section

Sit Exercise 10 Points

Note: Special provision for BH-VT in the general section

Down with recall 10 Points

Note: Special provision for BH-VT in the general section

Down under Distraction 10 Points

General Information Examination in traffic

Egon Gutknecht



[Zurück](#)

[Dashboard](#)

The exercises listed below are conducted in a suitable public area outside of the training field. The judge and the trial secretary determine where and how the traffic exercises will be conducted (streets, walkways or squares). Public traffic may not be interfered with. The implementation of this part of the examination requires a considerable amount of time because of its nature. The performance requirements must not be impaired by the superficial acceptance of many dogs. Points are not given for the individual exercises of part B. During Part B the overall impression about the dog moving in the traffic / public area is most important. The exercises described below are suggestions and can be modified individually to the local conditions by the performance judge. The performance judge is entitled to repeat or vary in case of doubt in the assessment of the dog exercises.

Examination procedures

(The following exercises represent a minimum requirement and can be extended by the national organizations). Encounter with group of persons

Egon Gutknecht



[Zurück](#)

[Dashboard](#)

At the order of the judge, the dog handler, with his dog, walks on the sidewalk. The performance judge follows the team at a reasonable distance. The dog is to follow on the dog handler's left side on a loosely hanging leash - with the shoulder at the knee height of the dog handler. The dog has to be indifferent to the pedestrian and driving traffic. On his way, the dog handler is stopped by a passing stranger. The dog has shown itself neutral and unimpressed. The dog handler and the dog continue through a relaxed group of at least 6 persons, in which a person responds to the dog handler and greets them with a hand shake. The dog has to sit or lie beside the dog handler and has to keep quiet during the short conversation.

Encounter with Bicyclists

Egon Gutknecht



[Zurück](#)

[Dashboard](#)

The dog is walking along a path with his dog handler and is overtaken by a bicyclist from behind who rings a bell. After a good distance, the cyclist turns to meet dog handler and dog. There will be another bell ring. The passing has to be done in such a way that the dog is between the dog handler and the bicyclist passing by. The dog has to see the bicyclists.

Encounter with Cars

Egon Gutknecht



[Zurück](#)

[Dashboard](#)

The dog handler walks past several cars with his dog. One of the vehicles is started. In another car, a door is shut. While the dog handler and the dog go on, a car stops next to them. The window is rolled down and the dog handler is asked for information. The dog has to sit or lie down by the dog handler's instructions. The dog has to be quiet and unimpressed with cars and all traffic noises.

Encounter with other dogs

Egon Gutknecht



[Zurück](#)

[Dashboard](#)

In the case of passing or encountering another dog and his handler, the dog is to remain neutral. The handler may give and repeat the command “Fuss/Heel” or place the dog in a sit or down position.

Behaviour of the tethered dog, which is left alone in the short term and behaviour towards animals

Egon Gutknecht



[Zurück](#)

[Dashboard](#)

At the order of the performance judge, the dog handler, with a dog, is walking along the sidewalk of a moderately busy street. After a short distance, the dog handler stops at the order of the judge and attaches the leash to a fence, wall or something similar. The dog handler goes out of sight into a store or a house. The dog may be standing, sitting or lying. During the absence of the dog handler, a passer-by (pedestrian) passes the dog with a dog at a lateral distance of about five paces away from the test dog. The dog left alone has to be quiet and calm during the absence of the handler. The dog (no dog aggressive dogs are to be used) passing by has to pass without the test dog showing aggression (strong pulling on the leash, continuous barking). After the direction from the judge, the dog is picked up again. Note: It is up to the judge (LR) to decide whether to carry out the individual exercises with each dog at the same location, or to have all the test dogs complete only a few exercises and then to go to another location and proceed there as well.

Phase A – Tracking: General Rules IGP 1-3, IFH-V, IFH-1, IFH-2, IGP-FH

Egon Gutknecht

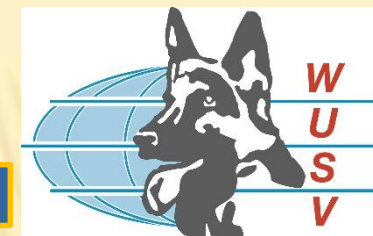

[Zurück](#)

[Dashboard](#)

Strangetrack = Fr Own track = E	IGP-1	IGP-2	IGP-3	IFH-V	IFH-1	IFH2	IGP-FH
Track	E	Fr	Fr	E	Fr	Fr	Fr
Minimum Length	300 Paces	400 Paces	600 Paces	600 Paces	1200 Paces	1800 Paces	2 x 1800 Paces 2 different places, 2 different track layers. On 2 different days for the test.
Legs	3	3	5	5	7	8, of which 1 is a semicircle with 30m Radius	8, of which 1 is a semicircle with 30m Radius
Corners	2	2	4	4, of which 3 are right angles, the last angle is executed as an acute angle	6 Right angles	7 of which at least 2 acute angles (30-60 degrees)	7 of which at least 2 acute angles (30-60 degrees)
Distance between the corners	Minimum 50 Paces	Minimum 50 Paces	Minimum 50 Paces	Minimum 50 Paces	Minimum 50 Paces	Minimum 50 Paces	Minimum 50 Paces
Articles Point values	3 (Handler uses own articles) 3 x 7 Points each	3 (Stranger's articles) 3 x 7 Points each	3 (Stranger's articles) 3 x 7 Points each	3 (Stranger's articles) 3 x 7 Points each	4 (Stranger's articles) 3 x 5, 1 X 6 Points each	7 (Stranger's articles) 7 x 3 Points each	7 (Stranger's articles) 7 x 3 Points each
Placing the articles	1st on the first leg, 2nd on the second leg and 3rd at the end	1st on the first leg, 2nd on the second leg and 3rd at the end	1st on first or second leg but a minimum of 100 paces from start, 2nd on the instruction from the judge, 3rd at the end.	1st on first or second leg but a minimum of 100 paces from start, 2nd on the second or third leg, 3rd at the end.	1st a minimum of 100 paces from the start, 2nd and 3rd according to the track Layer sketch, 4th at the end.	1st a minimum of 100 paces from the start, 2nd – 6th according to the Track layer sketch (2 articles on one leg is permissible), 7th at the end.	1st a minimum of 100 paces from the start, 2nd – 6th according to the Track layer sketch (2 articles on one leg is permissible), 7th at the end.
Dimensions of articles in CM	L: 10 W: 2-3 H: 0,5-1	L: 10 W: 2-3 H: 0,5-1	L: 10 W: 2-3 H: 0,5-1	L: 10 W: 2-3 H: 0,5-1	L: 10 W: 2-3 H: 0,5-1	L: 10 W: 2-3 H: 0,5-1	L: 10 W: 2-3 H: 0,5-1
Ageing Time	20 Min.	30 Min.	60 Min.	90 Min.	120 Min.	180 Min.	180 Min.
Working Time Maximum	15 Min.	15 Min.	20 Min.	20 Min.	30 Min.	45 Min.	45 Min.
Cross track timing	----	----	----	----	30 minutes before the start	30 minutes before the start	30 minutes before the start
Prerequisite	BH /VT	IGP 1	IGP 2	BH/VT	BH/VT	IFH- 1	IFH- 2

IGP 2019



General Rules IGP-V und IGP-ZTP Tracks

[Zurück](#)

[Dashboard](#)

	IGP-V	IGP-ZTP
	Handler lays the Track	Handler lays the track
Minimum Length	200 Paces	300 Paces
Legs	2	3
Corners (Right angles)	1	2
Ageing Time	Work the Track Immediately- no age	20 Minutes
Working Time Maximum	10 Minutes	15 Minutes
Articles	2 Belonging to the Handler	3 Belonging to the Handler
Dimensions of articles in CM	Length 10 cm Width 2-3 cm Height 0.5-1 cm	Length 10 cm Width 2-3 cm Height 0.5-1 cm
Rating:	Working the track: 79 Points Articles: 21 Points	Working the track: 79 Points Articles: 7 Points Each
Prerequisite	BH-VT	BH-VT



Instruction: Only IFH 1, IFH 2 and IGP FH

[Zurück](#)

[Dashboard](#)

The crosstrack shall not be laid within 40 paces before or 40 paces after a corner, or across the first or last leg. It must be laid so that the track is not crossed below a 60 degree angle and must cross the track twice. The dog is allowed to check crosstracks if he does not leave the actual track. If the dog changes from the track to the crosstrack and follows more than one leash length, the track work must be terminated.

Instruction: Only IFH-2 and IGP-FH

Egon Gutknecht

[Zurück](#)[Dashboard](#)

The dog handler is allowed to ask the Judge to briefly interrupt the trackwork if he believes that he or his dog needs a short break due to physical condition and weather conditions (e.g., high heat). The pause taken shall be counted towards the available time to work the track. The dog handler is allowed to clean his head, eyes and nose during a break or while at an article. For this purpose, the dog handler can carry a wet cloth or a wet sponge. The cloth or sponge must be shown to the judge before the start of the track. No other tools are allowed.

Tracking Grounds

Egon Gutknecht



[Zurück](#)

[Dashboard](#)

Tracks may use all natural soils such as e.g. Grass, ploughed dirt and forest floor. In all trial levels adaptation of the tracks to the available tracking-grounds is possible.



Laying the Tracks

[Zurück](#)[Dashboard](#)

The performance judge or the Tracking Coordinator shall determine the course of the track depending on the existing terrain. At IFH-1, IFH-2, IGP-FH, the track layer receives a track sketch from the judge or the tracking coordinator. It includes terrain features (e.g., trees, wire poles, huts, etc.). The judge/tracking coordinator supervises the laying of the tracks and instructs the track layers. The tracks can be laid differently; corners and articles must not be at the same position or at equal distances for each track. The scent pad of the track must be marked by a sign which is placed directly into the ground to the left of the scent pad. The track layer stays briefly at the scent pad and goes in natural stride with normal steps in the directed direction. When laying the track, make sure that they are placed in natural gait. The corners are also set in normal gait, whereby it must be noted that a continuous track work must be possible. (See sketch). Help by the track layer by unnatural gait, scuffing or stomping is not permitted in the entire area of the track. Articles are not to be placed within 20 paces before or after the corner and must be on the track. After dropping the last article, the track layer must continue at least 10 paces in a forward direction.

The handler and dog must not be able to watch the track being laid.

The order of the participants is done with a draw after laying the tracks in the presence of the Judge LR.



Articles

[Zurück](#)[Dashboard](#)

Articles may not differ significantly in colour from the terrain. The Articles must be shown by the dog handler (IGP- V, IZTP, IGP-1, IFH-V) track layers (IGP-2, IGP-3, IFH-1, IFH-2, IGP-FH) before laying the track to the performance judge or tracking coordinator. Only articles that the tracklayer (FL) has carried for a minimum of 30 minutes may be used.

Within a track the articles must be made of different materials (e.g., leather, textiles, wood). In the case of Championships and FH examinations, the articles must be numbered. These numbers must be the same as the track number.

Indicating the Articles



Indicating

[Zurück](#)[Dashboard](#)

The indicating out can be done sitting, lying down and standing, or alternating. The articles must be indicated convincingly without the help from the dog handler. Once the dog has indicated the article, the dog handler drops the tracking line or puts it down, goes directly to the dog, picks up the article and displays it to the judge. This can be done either on the left or on the right side of the dog. The dog must be calm in this position. The indicating must be done in the direction of the track. Slightly crooked lying down, sitting or standing to the article is not faulty. The article must lie directly in front of, or between the front paws. The dog must remain calm in the position until restarted on the track. Articles that are found with strong help of the Handler HF are considered to be overrun. After the articles are displayed, a re-start is made with a command to track.



Pick up / Retrieve

[Zurück](#)[Dashboard](#)

The presentation of the retrieved article also effects overall indication of the articles. The dog may stop after picking up, sit down or retrieve the article. Picking up the article and laying down is faulty, as well as going forward with the article. During the retrieve of the article, the handler must stay at the end of the leash. The restart occurs where the dog handler removes the article.

If an article not shown by the dog cannot be found by the track layer, there is no point deduction here. In the event that several articles are not found, the dog handler is offered a re-track. If he does not accept this, the articles not found are considered to be overrun.

This regulation does not apply to IGP-1, IGP-V, IGP-ZTP and IFH-V where the handler lays the track. In these cases when an article is not found by the dog or by the dog handler on the ground, no points are earned for these articles.



Track with a tracking line

[Zurück](#)[Dashboard](#)

The dog can track on a 10 m long line. A check of the line length, the collar or the harness by the Judge must be carried out before the start of the track work (at the latest, at the time of reporting in). Flexible Leashes are not permitted. The track line can be over the back, on the side of the dog or between the front and / or rear legs. It can either be attached directly to the loose fitting collar or to the attachment ring of the harness (chest or Böttger harness without additional straps). If a harness is used, make sure that the back strap does not extend beyond the last rib of the dog. The tracking line may sag during the track, but the required distance from the dog must not be seriously shortened. Ground contact of the line is not faulty.

Free Tracking

Egon Gutknecht



[Zurück](#)

[Dashboard](#)

When tracking off leash, the distance of at least 10 meters must be kept.

Report in / Report out

Egon Gutknecht



[Zurück](#)

[Dashboard](#)

When the team has been called, the handler report in prepared for tracking (the line has to be run out and if a harness is to be used it must be on the dog) in the basic position at the judge and indicates whether his dog retrieves or indicates the articles. The dog is allowed to be on a short line up to about 2 meters before the start. All compulsion is to be avoided before and during the entire track. At the instruction of the judge the dog is led to the scent pad and started. A short sit of the dog in front of the scent pad (approx. 2 meters away) is permitted so the tracking line can be brought to the position desired by the handler (attachment of the harness, line between front and/or rear legs). After completion of the track work, the articles found must be shown to the judge. Playing or feeding after indicating the last article, before checking out and receiving the score is not permitted. The checking out must take place in the basic position. After this, the short line can be put on the dog.



Working the Track

[Zurück](#)[Dashboard](#)

The dog must be given a verbal command to track at the scent pad. The handler has a Maximum of 3 commands to start his dog. The second and third attempts lead to a deduction in the evaluation of the first leg. The dog must take the track with a deep nose and then work the track with a deep nose, high tracking intensity, consistent and even speed. The search speed is not a faulty criterion if the dog is tracking in a convincing and intensive manner. The start (also when restarting after the finding of the articles) has to be done with the handler giving a verbal command to track and the handler standing upright. A certain amount of slack in the leash is permitted in using the line. The scent pad is not time-dependent, but the judge must pay attention to the behaviour of the dog at the beginning of the first leg as to how intensely he orients himself to the track and taking the scent. If the dog is caught in the tracking line, the handler may ask the judge to be able to untangle the dog, the command to restart is given from the end of the tracking line. There is no deduction.



Only IFH-1 / IFH-2 / IGP-FH

[Zurück](#)

[Dashboard](#)

If the handler has the impression that the dog has not correctly taken the track, he is free to recall the dog and restart again. This is only possible once and only if the handler has not left the scent pad yet. This is subject to a mandatory deduction of -4 points.



Corners

[Zurück](#)[Dashboard](#)

The dog must work out corners confidently. Circling at the corner is faulty. A head check without leaving the track is permitted. After the corner, the dog must continue with the required high intensity and at the same speed.

Through the corner, the handler must maintain the prescribed distance. He does not necessarily have to follow the track. However, the handler is not permitted to leave the track until the dog has changed direction and is committed to the next leg.



Praise

[Zurück](#)[Dashboard](#)

An occasional praise on the track is at all trial levels permissible, excluding IGP-3, IFH-1, IFH-2 and IGP-FH, but not in the corners (dogs body length before and after the corner). In addition, a short praise at the article is permitted in all levels. This can be done before or after the display of the article, but not both.



Termination / Disqualification

[Zurück](#)[Dashboard](#)

If the dog leaves the track and is held back by the dog handler, the judge will instruct the handler to follow the dog. If the judge's instruction is not followed, the track work must be terminated. If the end of the track is not reached within the maximum allowed time, specified in the individual levels, the track work is terminated by the Judge. This does not apply if the dog is on the last leg of the examination stages FH 1, FH 2 and IGP FH. The performance shown until termination is evaluated. If the dog quits tracking (stays in the same place without working, lifting its head etc.), the track can be terminated even if the dog is still on the track and the available time for the working the track has not yet expired.

If during the tracking work wild game appears, and the dog follows his hunting instinct, the handler may attempt to prevent the dog from following by giving the dog the command to down. On the judge's signal, the tracking work will continue with the handler giving the command to track from the end of the tracking line. If the dog fails to continue tracking the dog is to be disqualified. Rating: Disqualification for disobedience.

Further evaluation criteria / responsibilities of the Judge (LR)

Egon Gutknecht



[Zurück](#)

[Dashboard](#)

The assessment of each leg depends on the length, the terrain and the weather conditions, and is based on the title. The judge (LR) and all accompanying persons may not be in the tracking area where the dog and handler (HF) have the right to track (10 meters radius around the handler and 10 meters distance to the next track), the dog must not be disturbed by either the track layer or the judge.

The performance judge (LR) must not only look at the dog or the dog handler, but must also take into account the terrain, the weather, possible distractions and the time. The judge (LR) must base his assessment on the totality of all influencing variables. The assessment is to be carried out taking into account the following criteria.

- Tracking (e.g., motivated behaviour of the dog with constant intensity and consistent speed before and after the corners, as well as before and after indicating the articles).
- Training level of the dog (e.g. hectic approach, stressed behaviour, avoidance behaviour)
- Handler (HF) carrying aids that are not permitted
- Difficulties in working out the tracks:
 - o Tracking conditions (vegetation, sand, terrain changes, manure)
 - o Wind conditions
 - o Wild game
 - o Weather (heat, cold, rain, snow)
 - o Weather changes

The performance judge (LR) must assess the desire, the confidence, working temperament, the sureness or uncertainty of the dog in his work.



Deductions for all examination levels

[Zurück](#)[Dashboard](#)

- If the dog stops tracking by falsely indicating an article and the dog handler (HF) does not go to the dog but gives an extra command at the end of the tracking line "Such" -> -2 points. In IFH-2 / IGP-FH - 1 point
- If the dog stops tracking by falsely indicating an article and the dog handler (HF) does go to the dog, and gives the tracking command at the side of the dog "Such" -> -4 points. In IFH-2 / IGP-FH - 2 points
- Wondering, urinating or defecating, circles at the corners, continuous encouragement, line or verbal help in the track or at the articles are faulty and deducted accordingly.

Phase B –Obedience
General Provisions
Basic requirements

Egon Gutknecht



[Zurück](#)

[Dashboard](#)

Basic requirements

- o Attitude
- o Self Confidence
- o Outgoing, Motivated work
- o Concentration/Attention
- o Harmony of the Team

Technical correctness

- o Position
- o Willingness / Execution

Before the start of the Obedience Phase (B), the Judge must check the field and the equipment to be used during the trial (Examples: Jump, Wall, Dumbbells and field markings) to ensure they meet the requirements in the IGP regulations.
When assessing each exercise, the dog's behaviour must be carefully observed, starting with the basic position until the end of the exercise.



Commands

[Zurück](#)[Dashboard](#)

If a dog does not perform an exercise after the third given command, the exercise must be terminated without evaluation, 0 pts. When recalling, the name of the dog can be used instead of a recall command. The name of the dog in connection with any command is considered as a double command.

The reaction of the dog to the command:

The dog should perform the exercise quickly and without stress on the handler's command. Any behaviour of anxiety or stress depreciates the exercise.

Additional Commands:

If the dog does not execute an exercise after the second additional command, the exercise will be rated with 0 points. If the dog executes an exercise with two additional commands, the exercise is rated max high Insufficient.

1st Additional Command: "Satisfactory" for that part of the exercise 2nd Additional Command: "Insufficient" for that part of the exercise

Example: 5 Points for partial exercise:

1st Additional Command: "Satisfactory" rating from that portion of the exercise = -1.5 points 2nd Additional Command: "Insufficient" rating from that portion of exercise = -2.5 points

If the dog executes an exercise without a command, the partial exercise is to be rated "Insufficient"



Distribution and Point values of the exercises in the individual levels IGP 1 - 3

[Zurück](#)
[Dashboard](#)

Exercise	IGP-1	IGP-2	IGP-3
Heeling	15 Points	15 Points	15 Points
Sit out of motion	10 Points	10 Points	5 Points
Down with recall	10 Points, From a Walk	10 Points, From a walk	10 Points From a Running Pace
Stand out of motion		5 Points From a Walk with pick up	10 Points From a running pace with Recall
Retrieve on the Flat	15 Points	10 Points	10 Points
Retrieve over the 1 Meter Jump	15 Points	15 Points	15 Points
Climbing over the Scaling wall	15 Points A climb without retrieving	15 Points Climbing both ways with retrieve	15 Points Climbing both ways with retrieve
Send Out with Down	10 Points	10 Points	10 Points
Down under Distraction	10 Points	10 Points	10 Points
Total	100 Points	100 Points	100 Points
Exercise	IBGH-1	IBGH-2	IBGH-3
Heeling on Leash	30 Points	20 Points	
Free heeling	30 Points	20 Points	20 Points
Sit out of Motion	15 Points	15 Points	10 Points
Down out of Motion	15 Points	15 Points	10 Points
Stand while walking			10 Points
Retrieve on the Flat		10 Points	15 Points
Retrieve over the Scaling Wall (140 cm)			15 Points
Send Out with Down		10 Points	10 Points
Down under Distraction	10 Points	10 Points	10 Points
Total	100 Points	100 Points	100 Points



Specialties in IBGH 3

[Zurück](#)[Dashboard](#)

Specialties in IBGH 1 - 3:

In all levels in which the dog is called by the dog handler to come and in all retrieve exercises, it is not obligatory for the dog to sit in front of the dog handler. The dog can go right away in the end- basic position. Before release the dumbbell there must be a pause of 3 sec, before the dog handler takes the dumbbell from the dog with the verbal command „out“.

Special Requirements in the IBGH 3

The order of exercises 2 through 6 are decided by the performance judge from the following 5 Options:

Option 1 :

Exercise 2, 4, 5, 6, 3

Option 2 :

Exercise 4, 3, 6, 2, 5

Option 3 :

Exercise 6, 4, 5, 3, 2

Option 4 :

Exercise 3, 2, 6, 5, 4

Option 5 :

Exercise 5, 6, 3, 2, 4

All participants must perform exercises 2 to 6 in the same order



Exercises in IGP-V and IGP-ZTP

[Zurück](#)
[Dashboard](#)

Exercise	IGP- V	IGP- ZTP
Heeling on Leash	30 Points	25 Points
Free heeling	20 Points	
Sit out of Motion		15 Points
Down with recall	15 Points	20 Points
Retrieve on the Flat	15 Points	20 Points
Jump over a hurdle (80 cm)	10 Points	10 Points
Down under Distraction	10 Points	10 Points
Total	100 Points	100 Points

**Note**[Zurück](#)[Dashboard](#)

At the beginning of Phase B (Obedience) the handler report in with his dog to the performance judge. This is done with a dog on leash, except in IGP-2, IGP-3 and IBGH-3.



Start and end of an exercise

[Zurück](#)[Dashboard](#)

The judge gives the instruction for starting an exercise. Everything else during the exercise, such as turns, stops, pace changes etc. are executed without instruction. The specified time intervals, approx. 3 seconds, must be observed. For instance, into the final basic position, holding – outing the dumbbell, praising the dog and reset for beginning a new exercise. If the dog handler misses an exercise, the handler is asked by the judge to restart and show the missing exercise. There is no point deduction. Omission of or partial exercises result in deductions.

[Zurück](#)[Dashboard](#)

Basic Position

Each exercise begins and ends in the basic position. The basic position may be taken only once in the forward direction before each exercise. In the basic position the dog must be attentive to the dog handler and sit with shoulder blade at knee height to the left of the handler and parallel (straight along side) of the handler. In the basic position, the dog handler must not have a splayed leg stance and both arms must be loosely hanging at the side of the body.



Build-up

[Zurück](#)[Dashboard](#)

The build-up (development) is carried out from the basic position during the exercises "Sit out of motion", "Down out of Motion", "Stand out of motion" (IBGH 3) "Standing while walking" and "Send out with down". It must be at least 10, but no more than 15 paces, before the command is given to perform the exercise.



[Zurück](#)

[Dashboard](#)

Pick Up

During the exercises in which the dog is picked up again, the dog handler can approach the dog from the front, or from behind.



Recall / Front / Finish

[Zurück](#)[Dashboard](#)

When recalling the dog, the name of the dog can also be used instead of a recall command. The name of the dog in connection with a command is considered a double-command. The dog must be confident, fast, purposeful and direct to recall, and must sit tightly and straight in front of the handler. The dog has to go directly to the final basic position upon the command for the basic position. This can be done by the dog pivoting into basic position or by the dog going around behind the handler into basic position.

Exception for IBGH-1 to IBGH-3: When recalling, the dog does not have to show a front position, but may come directly into the basic position.



[Zurück](#)

[Dashboard](#)

Praise is only allowed in the basic position after each completed exercise. If this is also the new starting position for the next exercise, a 3 second pause must be observed.



Incorrect Positions

[Zurück](#)[Dashboard](#)

In the case of all “out of Motion” exercises (sitting, downing, standing), in addition to further mistakes, the entire exercise will be depreciated by 50% in the case of a position error. (Example: Standing during the Sit out of Motion exercise)



Releasing the Dumbbell upon command

[Zurück](#)

[Dashboard](#)

If the dog does not release the dumbbell after the third command, the dog is disqualified (DQ) for disobedience and does not proceed to complete any additional exercises or phases.



Dumbbell

[Zurück](#)
[Dashboard](#)

For the retrieve exercises only dumbbells which are provided by the organizers of the examination are to be used. Exception: in the IBGH 2 and IBGH 3 examinations, a dumbbell belonging to the handler may be used.

All participants must use the same dumbbells.

The following provisions must be met by the dumbbells:

- The dumbbell must be made of wood.
- The predetermined weights must be correct.
- The distance from the dumbbell bar to the ground must be at least 4 cm

	IBGH-2	IBGH-3	IGP-1	IGP- 2	IGP-3
On the Flat	Handler's own dumbbell	Handler's own dumbbell	650 Grams	1000 Grams	2000 Grams
Hurdle			650 Grams	650 Grams	650 Grams
Scaling Wall		Handler's own dumbbell	No Dumbbell	650 Grams	650 Grams
	IGP -V	IGP- ZTP			
On the Flat	Handler's own dumbbell	650 Grams			



Hurdle

[Zurück](#)[Dashboard](#)

The hurdle has the following dimensions: height 100cm, width 150cm. **Practice jumps are not allowed during the examination.**



Scaling Wall

Egon Gutknecht



[Zurück](#)

[Dashboard](#)

The scaling wall consists of two climbing walls, 150 cm wide and 191 cm long, connected at the top. On the ground, these two walls are spread apart so that the vertical height is 180 cm to the peak. The entire surface of the inclined wall must be covered with a non-slip material. On both sides of the wall, 3 cleats 24/48 mm are attached in the upper half. All dogs in a test must climb the same obstacles. Practice jumps are not permitted during the examination.

In IBGH-3, the scaling wall is set up with the base spread further apart to create a height of 140 cm at the peak.



Heeling on Leash and Free Heeling

[Zurück](#)[Dashboard](#)

The dog has to follow his dog handler out of the basic position with a verbal command to Heel, the dog must walk attentively, confidently with purpose, without stress and concentrated to the handler, and always remain with his shoulder at the knee on the handler's left side and parallel (straight) along the side of the handler. The pattern of the heeling is done according to the diagram below. The dog handler (HF) must take basic position at the starting point at the same time as when the second dog handler assumes the basic position for the exercise "down under distraction". On the first straight line, two shots a (calibre 6 mm) are fired at a time interval of 5 seconds apart with the first one after at least 15 paces, to check the gun sureness of the dog.

The gun shots are only fired in the exams IGP- V, IGP- ZTP and IGP-1 to IGP-3.

The dog must be indifferent to the gunshots. If the dog is gun shy he will be disqualified and all the points already acquired will be removed. If the response of the dog is not clear, the judge can check the gun sureness of the dog separately with additional shot.

(In the test stages BH-VT, IBGH-1 to IBGH-3 there are no gun shots fired).

About-turns are to show with the handler pivoting left. The dog may run around the back of the handler on the right hand side or remain in correct position on the left side and even with the knee of the dog handler. The running pace and the slow pace must be a distinct change of pace and clearly stand out from the normal pace. The speed change is carried out without intermediate paces.

After the second turn about, there must be shown a stop. Here the dog has to go into the „sit“ position without a verbal command.

Walking through a group of people that are moving is to be shown in the on leash heeling (IGP-V, IGP-ZTP, BH/VT, IBGH-1 and IBGH-2) and in heeling of leash (IGP 1-3, IBGH-2 und IBGH-3). The dog handler must circle a person to the right and circle a second person to the left (e.g. in the form of an 8) and stop at least once in the group with the dog performing an automatic sit near a person. The performance judge (LR) is allowed to request a repeat exercise. At the order of the performance judge (LR), the dog handler (HF) leaves the group with his/her dog and takes the final basic position. The dog's praise is only allowed in the final basic position after leaving the group.

Free Heeling is also to be shown when moving between the exercises. When picking up the dumbbells, the dog must be kept in the correct heeling position as described above.

Special Requirements BH-VT: The on Leash is carried out according to the heeling pattern. In the free heeling, go out straight 50 paces, about turn, the dog handler will walk 10 to 15 paces into the running pace, show 10 to 15 paces of the fast pace, then go without transition paces in a slow paces and after another 10 to 15 paces again Normal pace. The exercise ends with a final basic position.



Heeling Pattern Diagram

Zurück

Dashboard

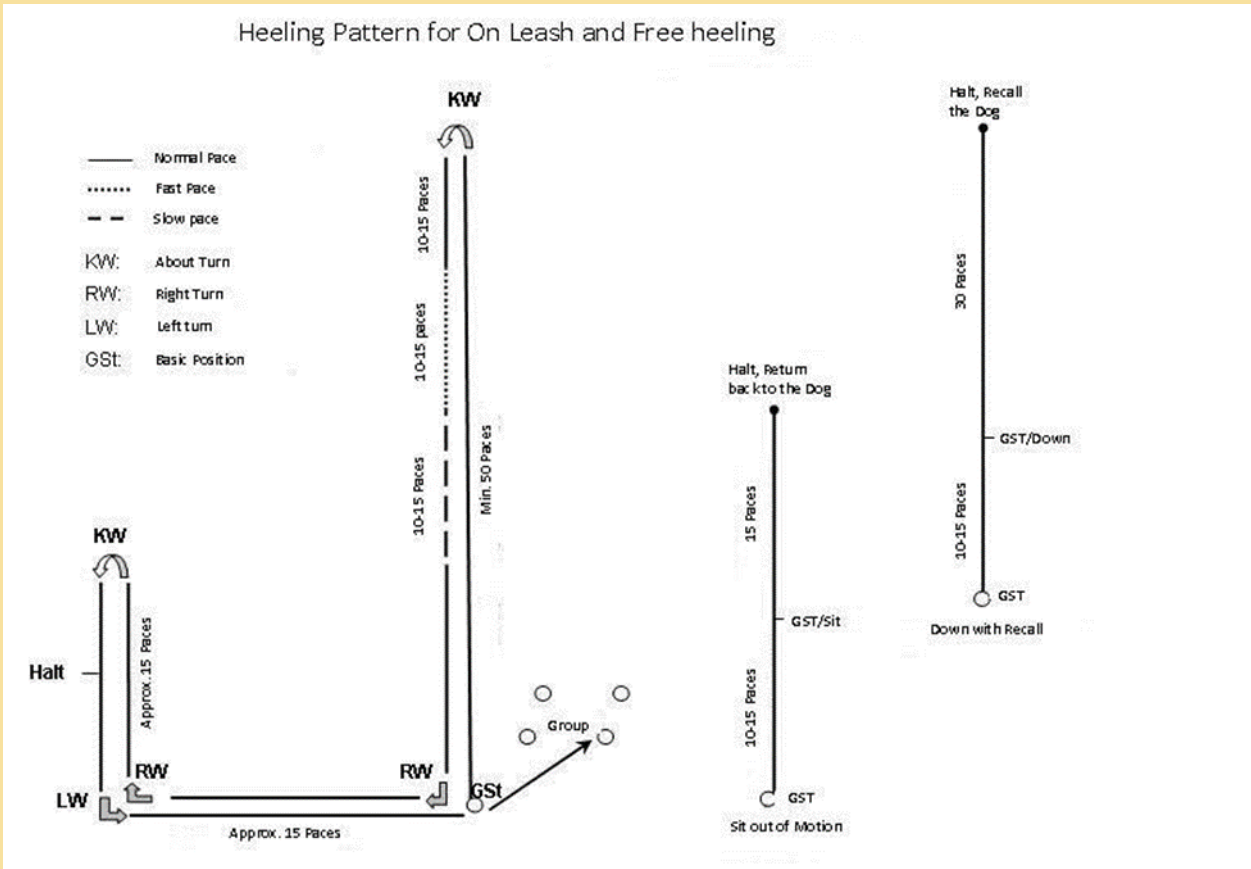

Execution

Egon Gutknecht



[Zurück](#)

[Dashboard](#)

The Handler (HF) checks In to the performance judge (LR) on leash in levels IGP-1, IBGH-1 and IBGH-2, IGP-V and IGP- ZTP and off leash in levels IGP-2 and 3, as well as IBGH-3. The handler (HF) checks in with the judge (LR) with his dog sitting in basic position in front of the Judge (LR).

After checking in with the judge (LR), when told to the dog handler (HF) goes to the start position at all levels (except BH-VT, IBGH-1 and IBGH-2) off leash. On further judge's (LR) instructions, the dog handler (HF) begins the exercise. From a straight, quiet and attentive basic position, the dog follows the Handler's (HF) command to "heel", without stress, confident, with purpose, straight and fast. With the dogs shoulder even with the handler's knee and parallel to the handler (HF) and must sit quickly and straight when stopping without a sit command.

At the beginning of the exercise, the handler (HF) goes 50 paces straight out without stopping. After the left about turn and another 10 to 15 paces, the handler (HF) will show the fast pace and the slow pace (10 - 15 paces each) with the "heel" command at each change of pace. The transition from the running pace to the slow pace must be carried out without transition paces.

The beginning basic position is also the place of the final basic position.

In the group, the dog handler (HF) has to go around a person both to the left and the right and must halt once in the group. At the instruction of the judge (LR) the handler leaves the group and assumes a basic position. The basic position is the beginning of the next exercise

The about turn can be shown in two variants. During an exam/ event it is only permitted to show one variant.

Evaluation criteria on Heeling on Leas and Free Heeling

Egon Gutknecht



[Zurück](#)

[Dashboard](#)

Forging, heeling wide, lagging, slow or hesitant sits, additional commands, handler help, errors in the initial position, inattentiveness, lack of motivation, stress and pressured behaviour of the dog, are faulty and lead to a corresponding deduction.

Sit out of Motion (all Examination levels)

Egon Gutknecht



[Zurück](#)

[Dashboard](#)

1st part: Beginning basic position, Build-up, Execution of Sit Command 50% of points

2nd part: Leaving the dog, attention and approaching of the dog handler, final basic position. 50% of the points After a build-up of 10 to 15 paces the dog must sit immediately upon the verbal command straight, without the dog handler (HF) changing his motion or looking back. The dog must remain calm and with attention to the dog handler (HF). In all test levels, the dog handler (HF) moves away 15 paces. On the judge's (LR) instructions, the dog handler (HF) returns to his dog.

Special provision for BH-VT: After the build-up, the dog handler (HF) may stop and give the command for sitting before he walks away from the dog.

Evaluation criteria on Sit out of Motion

Egon Gutknecht



[Zurück](#)

[Dashboard](#)

Slow sitting, restless and inattentive sitting is devalued in addition to other misconduct. If the dog stands or downs, the exercise is rated "Insufficient" mandatory -5 points (in IGP-3 mandatory -2.5 points).

Down with Recall

Egon Gutknecht

[Zurück](#)[Dashboard](#)

1st part: Beginning basic position, Build-up, Execution of down Command 50% of points

2nd part: Leaving the dog, Attention, Recall of the dog, front position, final basic position. 50% of the points

The build-up of 10 to 15 paces is carried out in the levels IGP-1 and IGP-2, IGP- V, IGP-ZTP and IBGH 1-3 in the normal Pace. In the IGP-3, the handler (HF) then proceeds additionally for 10-15 paces in a run. On the verbal command for downing, the dog must immediately down, straight in the direction without the handler changing his motion or looking back. The dog handler (HF) walks or runs at least 30 paces at the IGP-3, and turns directly to his dog. The dog must remain calm and attentive to the handler (HF) until the command. At the direction of the judge (LR), the handler (HF) recalls his dog with a recall command or the "dog's name". The dog must be fast, without stress, purposeful and come directly, sit close and straight in front of the dog handler. The dog has to go directly to the final basic position upon the command to finish.

Special provision for BH-VT: After the build-up, the dog handler may stop and give the command for downing before he walks away from the dog.

Evaluation criteria on Down with Recall

Egon Gutknecht



[Zurück](#)

[Dashboard](#)

Slow downing, restless or inattentive, slow non-purposeful recall, Handler help, e.g. splayed leg position, lead to corresponding deductions in addition to other misconduct. If the dog is sitting or standing, the exercise is „insufficient“ mandatory -5 Points.

For a dog that does not come on the second extra command, the exercise is to be evaluated Insufficient 0 Points. In this case, the dog may be picked up and Continue in the examination Level.

Stand while Walking IGP-2 and IBGH-3

Egon Gutknecht

[Zurück](#)[Dashboard](#)

1st part: Beginning basic position, Build-up, Execution of Stand Command 50% of points

2nd part: Leaving the dog, Attention and approaching of the dog handler, final basic position. 50% of the points After a build-up of 10 to 15 paces the dog must stand immediately upon the verbal command straight, without the dog handler (HF) changing his motion or looking back. The dog must remain calm and with attention to the dog handler (HF) while the dog handler moves away 15 paces and turns to face his/her dog. On the judge's (LR) instructions, the dog handler (HF) returns to his dog, stands on the right side and commands the dog into the basic position.

Evaluation criterial Stand while Walking

Egon Gutknecht



[Zurück](#)

[Dashboard](#)

Not immediately standing, restless or inattentive standing, and handler help lead to corresponding deductions in addition to other mistakes. If the dog sits or downs, the exercise has a mandatory **deduction of -5 points in IBGH-3 and - 2.5 points in IGP-2.**

Stand out of Motion (IGP-3 only)

Egon Gutknecht

[Zurück](#)[Dashboard](#)

1st part: Beginning basic position, Build-up, Execution of Stand Command 50% of points

2nd part: Leaving the dog, Attention, Recall of the dog, front position, final basic position. 50% of the points

After a Build-up of 10 to 15 running paces the dog must stand immediately upon the verbal command straight in the direction without the handler changing his motion or looking back. The dog handler runs at least 30 paces and turns directly to his dog. The dog must remain calm and attentive to the handler until the command. At the direction of the judge (LR), the handler (HF) recalls his dog with a recall command or the "dog's name". The dog must be fast, joyful, purposeful and coming directly, sit close and straight in front of the dog handler. The dog has to go directly to the final basic position upon the command to finish.



Evaluation criterial Stand out of Motion

[Zurück](#)[Dashboard](#)

Not stopping and standing immediately. Restless or inattentive standing, not fast and purposeful on recall, handler help, e.g. splayed leg stance, lead to a corresponding deduction in addition to other mistakes. If the dog sits or downs, the exercise will be evaluated „insufficient “with a mandatory -5 points. For a dog that does not come on the second extra command, the exercise is to be evaluated Insufficient 0 Points. In this case, the dog may be picked up and continue in the examination Level.

Retrieve on the Flat

Egon Gutknecht



[Zurück](#)

[Dashboard](#)

From a straight basic the handler (HF) throws the dumbbell approx. 10 meters away. If the handler's outside foot moves in order for the handler (HF) to throw the dumbbell no point loss as long as it does not affect the dog. If the leg is moved during the throw a 3 second pause must be shown after returning to basic position. The verbal command "Bring" may only be given when the dumbbell has stopped moving. On the verbal command for bringing the dog has to run directly to the dumbbell, pick it up immediately, turn directly and return to his handler (HF) directly. The aim is to show motivated and determined returns. During the presentation of the dumbbell and also during the retrieving portion, the dumbbell must be held firmly and calmly until the dog handler (HF) commands the dog to release the dumbbell after about a 3 second pause in front. The dog must present the dumbbell to the handler (HF). After putting the dumbbell and approx. 3 second pause, the dog is to be commanded to the basic position. The dumbbell is to be held in the right hand with the arm straight down at handler's side. The dog handler must place the dumbbell back on the stand.

Evaluation criterial Retrieve on the Flat

Egon Gutknecht



[Zurück](#)

[Dashboard](#)

The dog is slow, showing stress, unmotivated, not purposeful on the way out and/or return, faulty pick-up, dropping the dumbbell, playing with or mouthing the dumbbell, splayed leg stance by the handler, mistakes in the presentation, front and in the basic positions (for example, restless behaviour) result in deductions as well as any handler help.



Basic Position in Front of the Hurdle and scaling wall

[Zurück](#)[Dashboard](#)

The distance for basic position of the dog handler (HF) in front of the jump and scaling wall must be at **least 4 meters**.



Retrieve over the 1m hurdle

[Zurück](#)[Dashboard](#)

The handler (HF) takes the basic position with his dog at least 4 meters in front of the hurdle. The dumbbell will be made of a straight piece of wood (weight 650 grams) over a 100 cm high hurdle. The handler (HF) is allowed to move one foot when throwing. After the leg is returned to basic position, a pause of approx. 3 seconds is required. The dog should sit freely and quietly next to his dog handler (HF). On the command for jumping, the dog has to carry out the jump, during the jump the command is given for retrieving. The dog has to go quickly and directly to the dumbbell, pick it up immediately and return over the hurdle directly. The dog has to carry out the entire exercise without stress in a motivated way and show powerful smooth jumps without touching the hurdle. During the presentation and during the retrieving process, the dumbbell must be held firmly and calm until the dog handler (HF) gives the command to release the dumbbell after a 3 second pause in the front position. The dog must present the dumbbell to the handler (HF). After outing the dumbbell and approx. 3 second pause, the dog is to be commanded to the basic position. The dumbbell is to be held in the handlers (HF) right hand with the arm straight down at handler's side. The dog handler (HF) must place the dumbbell back on the stand.

Evaluation criterial Retrieve over the 1m hurdle IGP 1 – IGP 3

Egon Gutknecht



[Zurück](#)

[Dashboard](#)

The dog is slow, stressed, unmotivated, not purposeful on the jump out and/or jump back, faulty pick-up, dropping the dumbbell, playing with or mouthing the dumbbell, splayed leg stance by the handler, mistakes in the presentation, front and in the basic positions (for example, restless behaviour) result in deductions as well as any handler help.

A partial score for the exercise is only possible if the three parts (going- out jump - return - Retrieve) at least one jump and the "Retrieve" portion is completed.

For a jump not shown, there is a mandatory deduction of -5 points, in addition to other mistakes Dog does not jump one direction, either out or back, dumbbell retrieved flawlessly: 10 points Dog jumps perfectly out and back but does not retrieve the dumbbell: 0 points

If the dog knocks the hurdle over at the jump, a mandatory deduction of 5 points is required. The exercise is repeated. In the repeated exercise only the return jump, front, hold, out and final basic position are judged. If the dog (IGP-1 – IGP-3) touches the jump one point is deducted per jump, stepping on it, then 2 points are deducted per jump.



Climbing over the scaling wall (IGP-1 only)

[,Zurück](#)[Dashboard](#)

The dog handler (HF) takes the basic position in front of the scaling wall. After the command to sit, he goes to the other side and stands at a distance of at least 4 m to the scaling wall. On the judge's (LR) instructions, the handler (HF) calls his dog with the commands for jumping and coming. The dog must come with powerful climbing to his dog handler and sit straight and close in front.

After a 3 second pause, the handler (HF) gives the command for the dog to go into the final basic position.

Evaluation criterial Climbing over the scaling wall (IGP-1 only)

Egon Gutknecht

[Zurück](#)[Dashboard](#)

Mistakes in the basic position, hesitant, stress or powerless climbing, mistakes in front position, finish to basic position and handler help lead to deductions.



Retrieve over the scaling wall

[Zurück](#)[Dashboard](#)

The handler (HF) takes the basic position with his dog at least 4 meters in front of the scaling wall. The dumbbell will be made of a straight piece of wood (weight 650 grams) over a 180 cm scaling wall. The handler (HF) is allowed to move one foot when throwing. After the leg is returned to basic position, a pause of approx. 3 seconds is required. The dog should sit freely and quietly next to his dog handler (HF). On the command for jumping, the dog has to carry out the climbing, during the climbing the command is given for retrieving. The dog has to go quickly and directly to the dumbbell, pick it up immediately and return over the hurdle directly. The dog has to carry out the entire exercise in a motivated way without stress and show powerful smooth climbing. During the presentation and during the retrieving process, the dumbbell must be held firmly and calm until the dog handler gives the command to release the dumbbell after a 3 second pause in the front position. The dog must present the dumbbell to the handler. After outing the dumbbell and approx. 3 second pause, the dog is to be commanded to the basic position. The dumbbell is to be held in the right hand with the arm straight down at handler's (HF) side. The dog handler (HF) must place the dumbbell back on the stand.



Evaluation criteria Retrieve over the scaling wall

[Zurück](#)[Dashboard](#)

The dog is slow, unmotivated, stressed not purposeful on the jump out and/or jump back, faulty pick-up, dropping the dumbbell, playing with or mouthing the dumbbell, splayed leg stance by the handler, mistakes in the presentation, front and in the basic positions (for example, restless behaviour) result in deductions as well as any handler help.

A partial score for the exercise is only possible if the three parts (going- out climb - return - Retrieve) at least one jump and the "Retrieve" portion is completed. For all jumps not shown, there is a mandatory deduction of -5 points, in addition to other mistakes.



Send out with Down

[Zurück](#)[Dashboard](#)

1st Part: Basic Position, Buildup, execution of the send out portion. 50% of the points

2nd Part: after instruction from the Judge, Downing, final basic position. 50% of the points

If the dog does not go the minimum distance or cannot be stopped with 3 commands. There will be no evaluation of the exercise. On the single command "go out" and the raise of the arm, the dog handler (HF) sends his dog out and stands still. Then the dog has to go a minimum of at least 30 paces in the direction shown, straight forward, and in fast pace. At the direction of the judge, the dog handler (HF) gives the command for the dog to down, which the dog has to down immediately. The dog handler (HF) is allowed to hold the arm up in the direction of the exercise until the dog has downed. At the direction of the judge (LR), the dog handler (HF) goes to his dog and stands right next to him. At the instruction of the judge (LR), the handler (HF) gives the command for the dog to sit. The dog must sit quickly and straight in the basic position.



Evaluation criteria Send out with Down

[Zurück](#)
[Dashboard](#)

Mistakes in the buildup, slow, unsure or without purpose going forward, slow to down, restless while down and mistakes in the pickup and final basic position all lead to deductions.

Dog stops on first command but does not down, downs immediately on second command -1.5 Points.

Dog stops on first command but does not down, downs immediately on third command -2.5 Points.

Dog stops on first command but does not down on third command. -3.5 Points.

Dog does not stop on first command, stops and downs immediately on Second command -2.5 Points.

Dog doesn't stop on 1st or 2nd command, stops and down immediately on 3rd command -3.5 Points.

Dog cannot be stopped with 3 commands. 0 Points.

Dog downs directly on the first command, but after the judge's (LR) instructions to go pick up the dog, the dog breaks, the dog can be stopped by 50% of the distance to the handler (HF). Rating up to -5 Points.

Additional Mistakes are also deducted. Errors in the build-up, slow, unsure going forward, delayed stopping, slow to down, restless down as well as mistakes in the pick up, basic position lead to the additional deductions.



Down under Distraction

[Zurück](#)[Dashboard](#)

During the performance of motion obedience exercises of the other dog, the down exercise is shown under distraction. In doing so, the dog is placed on a position assigned by the judge from the basic position with the command to down. The dog handler then has to take the position on the instructions of the judge according to the examination level:

BH, IGP-1, IGP-2, IGP-V, IGP-ZTP and IBGH 1-3, the dog handler (HF) is at least 30 paces away in sight of the dog (but with the handler's back turned towards the dog).

IGP-3: Dog handler (HF) is at least 30 paces away and out of sight of the dog

The dog must lie quiet and calm without the influence of the handler while the other dog is working.

According to the information received on July 04th, 2019 the following applies for BH Down Position while distracted:

After having been recalled and taken the basic position the dog may be put on the lead again and with the lead on the dog may then be led to the place for the down position (this is not included in the examination regulations).

Down position under distraction.

The distance toward the dog during the exercise is supposed to be 30 paces for the BH examination.

A partial evaluation of the dog in case that the animal's early leaving of the down position is carried out once the 2 exercise of the other dog presented is finalized. In case that the dog approaches the handler while being picked up this entails a deduction of three points (previous procedure).

It is not explicitly defined in the examination regulations at which time the dog shall be picked up by the handler while performing the down position under distraction exercise. The committee for trial and training decided that prior to the send out exercise of the other dog the animal performing the down position shall be picked up from the handler upon command of the judge.



Evaluation criteria Down under Distraction

[Zurück](#)[Dashboard](#)

Mistakes in the basic settings, restless behaviour, stress, handler help, premature standing up, standing or sitting, leaving the designated area all lead to appropriate deductions. When leaving the down position by more than three meters, the following rules apply to allow a partial evaluation of -50% plus other mistakes:

IGP-1: Partial points are possible if the other dog has completed the third exercise.

IGP-2: Partial points are possible if the other dog has completed the fourth exercise.

IGP-3: Partial points are possible if the other dog has completed the fifth exercise.

IBGH 1: Partial points are possible if the other dog has completed the third exercise.

IBGH 2: Partial points are possible if the other dog has completed the fourth exercise.

IBGH 3: Partial points are possible if the other dog has completed the fifth exercise.

IGP-V: Partial points are possible if the other dog has completed the fourth exercise.

IGP- ZTP: Partial points are possible if the other dog has completed the fourth exercise.

If the dog goes to the handler when is approaching for the pick up, up to 3 points are deducted.

Praise

Egon Gutknecht

[Zurück](#)[Dashboard](#)

Praising is allowed after each completed exercise in the basic position. After this, the dog handler can take a new basic position, or pause for 3 seconds.



Mandatory Deductions

[Zurück](#)
[Dashboard](#)

	IGP-1	IGP- 2	IGP- 3
Sit out of Motion does not sit	- 5 Points	- 5 Points	- 2.5 Points
Down out of Motion Does not down	- 5 Points	- 5 Points	- 5 Points
Retrieve on the Flat Dog does not bring Motivate the dog, Handler leaves basic to get the dog to retrieve	0 Points Insufficient	0 Points Insufficient	0 Points Insufficient
Retrieve over 1m hurdle Just one direction jump No Jumps Does not complete Retrieve	- 5 Points - 15 Points - 15 Points	- 5 Points - 15 Points - 15 Points	- 5 Points - 15 Points - 15 Points
Climbing over scaling wall (only one direction) No climb over	-15 Points	Only climb 1 direction with retrieve -5 points No retrieve -15 points	Only climb 1 direction with retrieve -5 points No retrieve -15 points
Send Out with down See exercise description			

Phase C - Protection (IGP 1-3): General Provisions

Egon Gutknecht



[Zurück](#)

[Dashboard](#)

In all Protection exercises, the dog must only grip the protection sleeve provided for this purpose. Biting other unprotected body parts of the helper leads to immediate disqualification (DQ).

In countries where laws prohibit the stick test, these regulations can be implemented without it.

When stick tests are not prohibited, they are allowed only on the shoulders and in the area of the withers. In all periods of stress, the dog has to behave unimpressed, and to show a full, calm energetic and above all consistent firm grip during the entire exercise.

Field Markings

Egon Gutknecht



[Zurück](#)

[Dashboard](#)

The field markings must be clearly visible to the dog handler, the Judge (LF) and the helper:

- Position of the dog handler for the call out from guarding in the blind
- Position for the helper to start the escape and the distance (20 paces) that the dog must be engaged by. (See sketch page 51)
- Arc marking to position the dog behind during the setup for escape. (See Sketch)
- Marking for the dog handler for the exercise "Attack on the dog out of motion" (IGP3 Only)

Blinds

Egon Gutknecht

[Zurück](#)[Dashboard](#)

In a suitable location 6 blinds (3 blinds on each side) are staggered on each side of the field (see sketch). All 6 blinds places must be set up in all examination levels (IGP 1-3).



Basic requirements TSB

[Zurück](#)[Dashboard](#)

Assessing the instinctive behaviour, self-confidence, ability to cope with stress, grip performance and obedience is done over the entire protection routine. The dog has to show self confidence and power any time when searching for the helper.

Evaluation criteria

Restrictions on the following important evaluation criteria to be observed:

- The dog is not confident and unimpressed while responding to attacks, and has a less than a full, hard and calm grip until the release.
- The dog shows a lack of confidence during the exercise.
- The dog is not dominant, close, powerful while guarding the Helper HL.



RATING TABLE

[Zurück](#)

[Dashboard](#)

Deduction of One Category	<ul style="list-style-type: none"> • slightly inattentive guarding and / or slight bothering in the guarding phase
Deduction of Two Categories	<ul style="list-style-type: none"> • Very inattentive guarding and / or a lot of bothering in the guarding phase
Deduction of Three Categories	<ul style="list-style-type: none"> • the dog does not guard the Helper HL, but remains with the helper
Insufficient	<ul style="list-style-type: none"> • The dog leaves the helper to go to Handler during approach
Termination	<ul style="list-style-type: none"> • the dog does not withstand the pressure from the Helper HL and comes off the sleeve and backs up • the dog leaves the Helper HL before the Judge's instruction for the handler to approach or the dog handler gives a command for the dog to stay with the helper HL.



Extra Commands – Deductions

[Zurück](#)
[Dashboard](#)

Slow to Out	1 Extra Command with Immediate Out	1 Extra Command with Slow Out	2 Extra Commands, Immediate Out upon second command	2 Extra Commands, with slow Out upon second command	No Out after second extra command
0.5 – 3.0	3.0	3.5 – 6.0	6.0	6.5 – 9.0	Disqualification

If the dog does not release after the first command, the dog handler (HF) receives the instruction from the judge (LR) for up to two additional commands to out the dog.



[Zurück](#)

[Dashboard](#)

Examination Levels IGP-1 to IGP-3 (Exercises and Points Values)

Exercises	IGP-1	IGP-2	IGP-3
Search for the Helper	5	5	10
Hold and Bark	15	15	15
Prevention of Attempted Escape	20	15	10
Defense against an attack from the guarding phase	30	20	15
Back transport	-	5	5
Attack on the dog out of the back transport	-	-	15
Attack on the dog out of motion	30	20	15
Defense against an attack from the guarding phase	-	20	15
Total Score	100	100	100

Report in

Egon Gutknecht

[Zurück](#)[Dashboard](#)

The dog handler (HF) report in, in the basic position at the judge (LF). In the level of the IGP-1, IGP -V and IGP-ZTP with a dog on leash, in the level of IGP-2 and IGP-3, the dog handler (HF) reports with the dog off leash. Protection starts when the dog handler (HF) for the exercise "Search for the helper" is in basic position in the direction of the judge and the hand raised to acknowledge to the judge (LF) that they are ready to begin the search.

According to the information received on July 04th, 2019 the following applies in terms of the handler' s reporting in for the "search for the helper exercise":

The examination regulations are rather misleading in this respect. The handler is supposed to report in with the trial judge while in the basic position. However, the following sentence stipulates that protection starts when the dog handler (HF) for the exercise "Search for the helper" is in basic position in the direction of the judge and the hand raised to acknowledge to the judge (LF) that they are ready to begin the search.

According to the FCI committee the helper proceeds directly from the basic position to the Search for the helper" exercise, i.e. not at first to the trial judge. Taking the basic position and the raising of the hand are considered as reporting in for the exercise.

Search for the helper

Egon Gutknecht



[Zurück](#)

[Dashboard](#)

The start must take place in the basic position facing downfield to the Judge, after acknowledging the judge (LF) a new basic is taken in the direction of the first blind.

With a verbal command and a hand signals with the right or left arm for direction, the dog is sent to search the blinds. The dog has to run fast and directly at the blinds, it must go around them closely and attentively. After going around into the blind, the handler (HF) calls the dogs name and gives a voice command to "Come" toward him, then gives a verbal command and points to the next blind for searching. The dog handler (HF) moves in the normal pace on the imaginary centre line, which he must not leave during the blind search. When the dog has reached the helper's blind, no further commands or hand signals are permitted, and the dog handler must stop as soon as the dog enters blind 6 and remain standing until he receives an instruction from the judge (LR) to approach the dog for the call out or pickup.

According to the information received on July 04th, 2019 the following applies.

The handler may call the dog back from the blind by calling the command "Come" in addition to the hand sign.



**Description search für the helper IGP 1,2,3
Tabelle**

[Zurück](#)

[Dashboard](#)

IGP-1 1 Blind	IGP-2 4 Blinds	IGP- 3 6 Blinds
<p>The dog is heeled, on leash, to the starting position on the centre line even with blind 6, The handler assumes a basic position there and removes the leash. The handler raises an arm showing his willingness to start the exercise. After the judge signal the dog is sent directly to blind 6.</p>	<p>The dog is heeled, off leash, to the starting position on the centre line even with blind 3, The handler assumes a basic position there. The handler raises an arm showing his willingness to start the exercise. After the judge signal the dog is sent to start the search exercise.</p>	<p>The dog is heeled, off leash, to the starting position on the centre line even with blind 1, The handler assumes a basic position there. The handler raises an arm showing his willingness to start the exercise. After the judge signal the dog is sent to start the search exercise.</p>



Evaluation criteria Search for the helper

[Zurück](#)[Dashboard](#)

If the dog is not calm in the basic position at the beginning of the exercise, if the dog is barking or vocal during the search, if the dog receives additional commands or hand signals, if the handler (HF) leaves the imaginary centre line during search, the handler (HF) does not move at a normal pace, the dog circles the blind wide, the dog is acting independently and not on the handler's commands, if blinds are not circled or not attentively circled, the dog is difficult to control, these faults are deducted accordingly.

If the dog handler (HF) has his dog come into the basic position during the blind search (the dog stops the search and comes to basic position), the exercise is evaluated with zero points. The protection can be continued, if the dog can be sent on again, if he comes back to the basic position a second time, protection must be terminated.

If the dog does not find the helper on the first command, the handler (HF) has two more commands to try to get his dog into blind 6. If the dog does not find the helper on the 3rd command then protection is terminated

Hold and Bark (10 points for Hold and 5 points for Barking)



[Zurück](#)

[Dashboard](#)

The handler (HF) waits for instructions from the judge for retrieving the dog. The dog must confront the helper confident, actively, dominant, attentively and bark continuously. The barking duration is approx. 20 seconds before the judge (LR) signals for the handler (HF) to approach. The exercise ends as follows:

IGP-1	IGP-2	IGP-3
<p>The Judge instructs the handler when to go to the marked position 5 paces away from the helper. On the judge's instructions, the handler calls his dog into the basic position or, alternatively, moves up to his dog, takes him to the basic position with a command to sit, then puts the leash on and heels to the marked position and takes the basic position. The dog may also be kept off leash when heeling to the marked position.</p>	<p>The Judge instructs the handler when to go to the marked position 5 paces away from the helper. On the judge's instructions, the handler calls his dog into the basic position</p>	<p>The Judge instructs the handler when to go to the marked position 5 paces away from the helper. On the judge's instructions, the handler calls his dog into the basic position</p>

Evaluation criteria Hold and Bark

Egon Gutknecht



[Zurück](#)

[Dashboard](#)

Weakness or Limitations in dominance, continuous barking and confidence while holding the helper until the command to call out is given, are evaluated accordingly. During the exercise, the dog must not be distracted by the performance judge (LR) or by the dog handler (HF).



Evaluation criteria Hold and Bark (Table)

[Zurück](#)
[Dashboard](#)

<p>Weak, inconsistent, not dominate, non-energetic unfocused barking Dog does not bark, but actively guards the helper</p>	<p>Satisfactory to Insufficient Insufficient</p>
<p>Bothering the Helper by pushing, Bumping, etc. The dog bites the sleeve and only releases after approach and a command</p>	<p>Rated accordingly as low as Insufficient Insufficient – 14 Points</p>
<p>If the dog leaves the helper before the dog handler leaves the centre line after the judge's instructions. If the dog does not go back into the blind or leaves the helper again</p>	<p>The dog can be sent in again one time. If the dog remains with the helper, phase C can be continued. Low Insufficient rating for hold and bark. Termination</p>
<p>If the dog leaves the helper during the handler's approach, or if the dog comes out from the helper before the command</p>	<p>Rated as Insufficient Rated as Insufficient</p>
<p>If the dog is biting the sleeve in the blind and does not release on his own, the dog handler is instructed to go to the callout position. The handler is allowed to call the dog with a command to „out“ and a “here, heel“ command, which must be said in a one word manner.</p>	<p>If the dog comes out to basic position- Insufficient -14 If the dog does not release or come to basic with one command - Disqualification</p>



Prevention of an attempted escape of the helper

Commands for the Escape and Out

On the judge's (LR) instructions, the handler (HF) asks the helper to step out of the Blind. The helper goes at a normal pace to the starting point for the escape.

The handler (HF) heels his dog to the marked position for escape

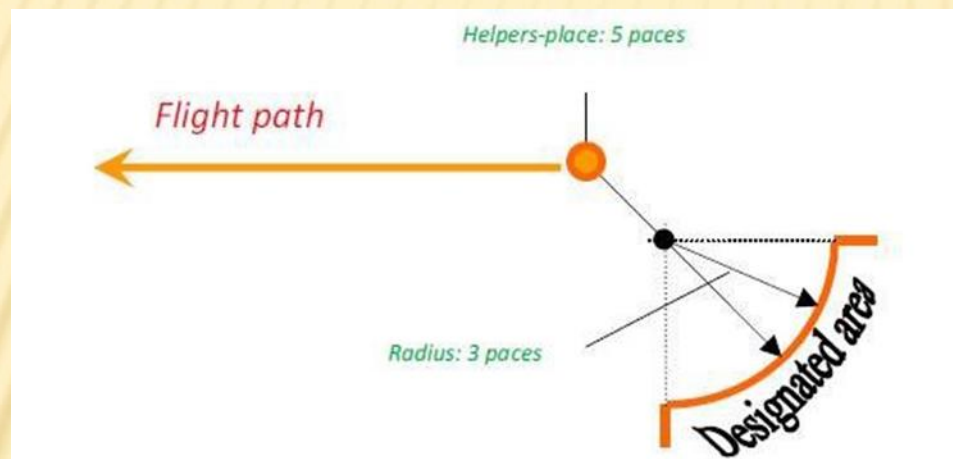
[Zurück](#)[Dashboard](#)



Prevention of an attempted escape of the helper IGP 1

[Zurück](#)[Dashboard](#)

IGP 1

The dog is either heeled on leash or off leash to the designated starting position for the escape. In doing so, the dog must be under control, attentive and concentrated, as well as in the correct position at the knee of the handler (HF). In the basic position, if the exercise is shown on leash, the leash is removed and then the dog is given the command to down. At the command the dog must lie down directly and quickly and must be calm, sure and attentive to the helper in the position. The distance between helper and the dog is 5 paces. The handler returns to the blind and remains there with a view on the dog and the judge. The judge (LR) signals the helper to escape.



Prevention of an attempted escape of the helper IGP 2 - 3

[Zurück](#)[Dashboard](#)

IGP-2 und IGP-3

The dog will be heeled to the designated starting position for escape and has to take a basic position there. In doing so, the dog must be under control, attentive and concentrated, as well as in the correct position at the knee of the handler. At the command the dog must lie down directly and quickly and must be calm, sure and attentive to the helper in the position. The distance between helper and dog is 5 paces. The handler goes back to the Blind and remains there with visual contact to the dog and judge. The judge (LR) signals the helper to escape.



Attempted Escape (IGP-1 – IGP-3)

[Zurück](#)[Dashboard](#)

After the judge's instructions, the helper attempts to escape. At the same time the handler gives a command for the dog to prevent the escape. The dog must without hesitation try to prevent the attempted escape with high determination, attempting to slow or control the helper with an explosive and powerful attack. From the lockup of the helper to the out, the transitional phase is about 1 sec. After a transitional phase, the dog must out (let go). The handler (HF) may give a command to out within an appropriate time (about 3 seconds). The following guarding phase before the Defense is approximately 5 seconds.

Evaluation criteria (IGP-1 – IGP-3)

Egon Gutknecht



[Zurück](#)

[Dashboard](#)

The dog does not react with a firm, fast, energetic and powerful grip and engagement and/or effective prevention of the escape. The dog does not remain quiet, calm and/or full on the grip until the release, not attentive, not dominant or bumping during guarding of the helper are deducted accordingly.

If no command to go (release) is given, the exercise is rated one category lower.

If the dog remains in the escape setup position, or if the helper is not caught (engaged) within 20 paces, protection is terminated.

According to the information received on July 04th, 2019 the following applies.

If the dog runs toward the helper before he begins the flight the dog is being **disqualified** in case that **he/she attacks**. If that is not the case the handler has the chance upon instruction by the judge to proceed to the marking for the down position place and call the dog back by calling the command “Come - Heel” – only one attempt is admitted – and order the down position. Following this the handler proceeds to the hiding place again. The exercise is rated with 0 points.



Defense of an attack from the guarding phase (IGP-1 – IGP-3)

[Zurück](#)[Dashboard](#)

Commands: 1 Commands for outing and 1 command for the basic position

After a guarding phase of approx. 5 seconds, the helper attacks the dog. The dog must defend itself without the influence of the handler by explosive and powerful strike with a firm and calm grip. The dog is to be pressured in the drive with stick threats by the helper. Particular attention must be paid to the dog's self-assurance, power, and a full, calm grip. Two stick hits are to be applied during the drive. At the order of the judge (LR), the helper stops the drive and pressure. After the helper has locked up, the transition phase must be displayed for approximately 1 sec after the helper has stopped. After the transition phase, the dog must release (out). The handler (HF) can give a command for the out in an appropriate time (1-3 seconds) on their own, additional commands to out will be directed by the judge. During and after the release (out) the helper has to stand still. After out the dog must guard the helper with powerful, attentive, showing confidence with high dominance.

End of the exercise IGP-1

Egon Gutknecht

[Zurück](#)[Dashboard](#)

The handler (HF) follows the judge's (LR) instructions to approach the dog, he does so directly in a normal gait, the handler (HF) stands next to his dog and returns him to the basic position with a command of Sit. The padded stick is not taken from the helper. The handler (HF) then heels the dog on leash down field to set up for the long attack. The dog may also be heeled down field off leash.



End of the exercise IGP-2 u. 3

[Zurück](#)

[Dashboard](#)

The handler (HF) follows the judge's (LR) instructions to approach the dog, he does so directly in a normal gait, the handler (HF) stands next to his dog and returns him to the basic position with a command of Sit. The padded stick is not taken from the helper.



Evaluation criteria (IGP-1 – IGP-3)

[Zurück](#)[Dashboard](#)

The dog does not react with a firm, fast, energetic and powerful engagement and/or effective prevention of the attack. The dog is not quiet, calm and/or full on the grip until the release, the dog is not attentive, dominant or bumping during guarding of the helper are deducted accordingly.



Back Transport IGP-2

[Zurück](#)[Dashboard](#)

Commands: Heel or Transport

The exercise begins with the end of the exercise "Defense against an attack from the guarding phase". The transport is carried out over a distance of 30 paces. A corner is not mandatory. The judge (LR) determines the course of the transport. The handler (HF) asks the helper to step back and move out and follows him with his dog, which is intensively attentive to the helper, at a distance of about 8 paces. This distance must be maintained during the entire back transport. The helper stops and stands still on the order of the judge. The handler (HF) goes to the helper with his dog who is attentive to the helper, stands beside the helper and takes the padded stick. The dog must sit in the basic position. Thereafter, a side transport to the judge is shown over a distance of about 20 paces. A command for the transport is allowed. The dog has to go between the helper and the handler. The dog must be attentive to the helper. However, he is not allowed to press, bump or grip the helper. At the end of the transport, the handler (HF) takes a basic position with his dog in front of the judge (LR), hands over the padded stick to the judge (LR) and announces the first part of protection is complete.

Gem. Schreiben vom 04.07.2019

Rückentransport IGP2:

Nach Einstellung der Verteidigungshandlung erfolgt ein Rückentransport über eine Distanz von 30 Schritten, der Abstand zwischen Hundeführer/Hund und dem Helfer betragen 8 Schritte. Auf RA bleibt der Helfer stehen, der HF geht mit seinem Hund direkt zum Helfer, ohne vorher ebenfalls anzuhalten, bleibt neben dem Helfer stehen und nimmt ihm den Stock ab. Danach erfolgt ein Seitentransport ca. 20 Schritt.

Rückentransport:

Wenn der Hund beim Rückentransport zum Helfer läuft und einbeißt, erfolgt eine **Disqualifikation**.
Läuft der Hund zum Helfer, ohne einzubeißen, hat der HF die Möglichkeit, den Hund mit einmaligem Hörzeichen zurückzurufen. Kommt er **auf einmaliges Hörzeichen nicht zurück**, erfolgt eine **Disqualifikation**.
Beim Vorgehen des Hundes hat der HF zwei Zusatzhörzeichen, den Hund in entsprechender Position (Freifolge neben dem Hundeführer zu halten. Gelingt dies trotz **2 Zusatzhörzeichen nicht**, erfolgt ebenfalls eine **Disqualifikation (wegen Ungehorsam)**).



Back transport IGP-3

[Zurück](#)[Dashboard](#)

Commands for the Transport

The exercise begins with the end of the exercise "Defense against an attack from the guarding phase". The transport is carried out over a distance of 30 paces. A corner is not mandatory. The judge (LR) determines the course of the transport. The handler (HF) asks the helper to step back and move out and follows him with his dog, which is intensively attentive to the helper, at a distance of about 8 paces. This distance must be maintained during the entire back transport.

Back transport:

If the dog runs towards the helper during the back transport and attacks him this entails a **disqualification**.

If the dog runs towards the helper without attacking the handler has the chance to call the dog back – however – with only one attempt admitted. In case that the dog **does not follow the one-time command** this also entails a **disqualification**.

If the dog walks ahead of the handler two more commands are admitted to keep the dog walking next to the handler while off the leash. If the dog fails in this exercise **despite two oral commands** this also entails a **disqualification because of disobedience**.



Back transport - Evaluation criteria

[Zurück](#)[Dashboard](#)

If the dog shows pressure or stressed behaviour, if the dog is not attentive to the helper, if dog is not in correct position with the handler (HF) or incorrect paces from helper. The exercise will be deducted accordingly.

Back transport:

If the dog runs towards the helper during the back transport and attacks him this entails a **disqualification**.

If the dog runs towards the helper without attacking the handler has the chance to call the dog back – however – with only one attempt admitted. In case that the dog **does not follow the one-time command** this also entails a **disqualification**.

If the dog walks ahead of the handler two more commands are admitted to keep the dog walking next to the handler while off the leash. If the dog fails in this exercise **despite two oral commands** this also entails a **disqualification because of disobedience**.

Attack on the dog from the Back Transport. IGP-3 only

Egon Gutknecht



[Zurück](#)

[Dashboard](#)

Commands: 1 Commands for outing and 1 command for the basic position

During the back transport and without stopping, at the direction of the judge, the helper attacks the dog without the intervention of the handler and without hesitation, the dog must engage the helper with a confident, powerful attack with a full firm and calm grip. After the grip the dog is to be pressured by being driven and threatened by the helper. Particular attention must be paid to the dog's self-assurance, power, and a full, calm grip. At the order of the judge, the helper stops the drive and pressure. After the helper has locked up, the transition phase must be displayed for approximately 1 sec after the helper has stopped. After the transition phase the dog must release. The handler can give a command for outing in an appropriate time independently. During and after the release the helper has to stand still. After outing the dog must guard the helper powerfully, attentively, confidently and with high dominance. On the judge's (LR) instructions the handler (HF) goes to the helper with his dog who is attentive to the helper, stands beside the helper and takes the padded stick. The dog must sit in the basic position. Thereafter, a side transport to the judge is shown over a distance of about 20 paces. A command for the transport is allowed. The dog has to go between the helper and the handler. The dog must be attentive to the helper. However, he is not allowed to press, bump or grip the helper. At the end of the transport, the handler (HF) takes a basic position with his dog in front of the judge (LR), hands over the padded stick to the judge (LR) and announces the first part of protection is complete.



Evaluation criteria back Transport (IGP-3 only)

[Zurück](#)[Dashboard](#)

The dog does not react with a firm, fast, energetic and powerful engagement and/or effective prevention of the attack. Not quiet, calm and/or full on the grip until the release, not attentive, dominant or bumping during guarding of the helper are deducted accordingly.

Attack on the dog out of Motion

Egon Gutknecht



[Zurück](#)

[Dashboard](#)

The helper yells and threatens the dog in all levels. The first yells are given when the helper HL turns up field to run towards the dog. The final yell and threat is when the dog is preparing to engage the helper.



Attack on the dog out of Motion IGP 1

[Zurück](#)[Dashboard](#)

IGP-1

The helper will stop where the previous exercise has ended. After the "Defense against an attack from the guarding phase", the dog handler (HF) takes his dog, on leash or off leash, about 30 meters away from the helper. The dog must be in the correct position on the knee of the dog handler (HF). After reaching the position for the set up, the handler stops and turns around. The dog is brought into the basic position with the command to sit. The dog, sitting calmly and attentively to the helper, can be held on the collar. He must not be stimulated by the dog handler (HF). At the order of the judge (LR), the helper attacks the dog frontally with yelling and making strong threatening motions. On the judge's (LR) instructions, the handler immediately releases his dog with the command to go. The dog must without hesitation engage of the helper with high dominance and determination. After the grip the dog is to be pressured by driving and threats with the padded stick by the helper. Particular attention must be paid to the dog's self-assurance, power, and a full, calm grip. The handler (HF) is not allowed to leave his place. At the order of the judge (LR), the helper stops the drive and pressure and places the back of the dog towards the handler (HF). After the helper has locked up, the transition phase must be displayed for approximately 1 sec after the helper has stopped. After the transition phase the dog must release. The handler (HF) can give a command to out in an appropriate time (1 – 3 seconds) independently additional commands to out will be directed by the judge.

During and after the release the helper has to stand still. After outing the dog must guard the helper with powerful, attentive, confidence with high dominance. On the judge's instructions (LR), the handler (HF) goes to his dog, returns him into the basic position with to sit and puts the leash him on. The padded stick is removed from the helper. The handler (HF) may disarm the helper any way he/she wants as long as the dog and handler remain together during the disarm. Then a new basic position is taken next to the helper and a side transport, either with the dog on leash or off leash, to the judge (LR) over a distance of about 20 paces. A command for heeling or transport is allowed. The dog has to remain between helper and the handler. The dog must be attentive to the helper during transport. However, he is not allowed to press, jump or grip the helper. If the dog leaves the position between the helper and handler the transport must stop and the handler (HF) has 3 commands to get the dog back to position between the handler and helper so the transport may continue. At the end of the transport, the handler takes a basic position in front of the judge, hands the padded stick to the judge (LR) and reports that protection is complete. The handler (HF) goes with his dog on leash, at the direction of the judge (LR), under control to the position for the critique.

According to the information received on July 04th, 2019 the following applies in terms of the side transport:

If the dog attacks the helper during the side transport the handler has the chance to give a one-time command to release the helper again and to return the dog into the respective position for the side transport. A failure results in a disqualification.

Attack on the dog out of Motion IGP 2

Egon Gutknecht



[Zurück](#)

[Dashboard](#)

IGP-2

The helper will stop where the previous exercise has ended. After the side transport at the end of the exercise "Back Transport", the dog handler takes his dog, off leash, about 40 meters away from the helper. The dog must be in the correct position on the knee of the dog handler. After reaching the position for the set up, the handler stops and turns around. The dog is brought into the basic position with the command to sit. The dog, sitting calmly and attentively to the helper, can be held on the collar. He must not be stimulated by the dog handler. At the order of the judge, the helper attacks the dog frontally with yelling and making strong threatening motions. On the judge's (LR) instructions, the handler (HF) immediately releases his dog with the command to go. The dog must without hesitation engage of the helper with high dominance and determination. After the grip the dog is to be pressured by driving and threats with the padded stick by the helper. Particular attention must be paid to the dog's self- assurance, power, and a full, calm grip. The handler (HF) is not allowed to leave his place. At the order of the judge (LR), the helper stops the drive and pressure and places the back of the dog towards the handler (HF). After the helper has locked up, the transition phase must be displayed for approximately 1 sec after the helper has stopped. After the transition phase the dog must release. The handler (HF) can give a command for outing in an appropriate time (1-3 seconds) independently additional commands to out will be directed by the judge. During and after the release the helper has to stand still. After outing the dog must guard the helper with powerful, attentive, confidence with high dominance for approximately 5 seconds.



Attack on the dog out of Motion IGP 3

[Zurück](#)[Dashboard](#)

IGP-3

The handler (HF), after the side transport at the end of the exercise "Attack on the dog from the back transport" he takes his free heeling dog to the marked place on the centre line even with the first Blind. The heeling has to show attention to the handler, stress-free and intensity from the dog. The dog is straight, right at the knee of the handler. After reaching the position for Long Attack the handler (HF) stops and turns around. With the command sit, the dog is brought into the basic position. The straight, quiet and attentive to the helper sitting dog can be held by the collar, but may not be stimulated by the handler. At the order of the judge (LR) the helper with a padded stick comes out of a blind and runs to the centre line. After reaching the centre line the helper turns up field and runs towards the handler (HF) and attacks, without interrupting his running pace, while yelling and making strong threatening motions. As soon as the helper is about 50 meters from the handler, on the judge's (LR) instructions, the handler (HF) immediately releases his dog with the command to go. The dog must without hesitation engage the helper with high dominance and determination. After the grip the dog is to be pressured by driving and threats with the padded stick by the helper. Particular attention must be paid to the dog's self-assurance, power, and a full, calm grip. The handler (HF) is not allowed to leave his place. At the order of the judge (LR), the helper stops the drive and pressure and places the back of the dog towards the handler (HF). After the helper has locked up, the transition phase must be displayed for approximately 1 sec after the helper has stopped. After the transition phase the dog must release. The handler can give a command for outing in an appropriate time independently (1-3 seconds) additional out commands will be directed by the judge. During and after the release the helper has to stand still. After outing the dog must guard the helper with powerful, attentive, confidence with high dominance for approximately 5 seconds.



Evaluation criteria Attack on the dog out of Motion (IGP-1- IGP-3)

[Zurück](#)[Dashboard](#)

The dog is not reacting with a firm, fast, energetic and powerful engagement and/or effective prevention of the attack. Not quiet, calm and/or full grip until the release, not attentive, dominant guarding of the helper are deducted accordingly.



Defense of an attack from the guarding phase, with completion of phase C IGP-2 and IGP-3

[Zurück](#)[Dashboard](#)

Commands: Out, Sit and Transport

After the exercise "defense against an attack out of motion", the helper on the judge's (LR) instruction undertakes an attack on the dog. The dog must defend itself without the influence of the handler (HF) by explosive and powerful strike. The dog is to be pressured in the drive with stick threats by the helper. Particular attention must be paid to the dog's self-assurance, power, and a full, calm grip. Two stick hits are to be applied during the drive (IGP-3 only). At the order of the judge (LR), the helper stops the drive and pressure. After the helper has locked up, the transition phase must be displayed for approximately 1 sec after the helper has stopped. After the transition phase, the dog must release. The handler can give a command for outing in an appropriate time (1-3 seconds) independently additional out commands will be directed by the judge. During and after the release the helper has to stand still. After outing the dog must guard the helper with powerful, attentive, confidence with high dominance.

On the judge's (LR) instructions, the handler (HF) goes to his dog, returns him into the basic position with the command to sit. The padded stick is removed from the helper. The handler (HF) may disarm the helper any way he/she wants as long as the dog and handler remain together during the disarm.

Then a new basic position is taken by the handler (HF) and dog next to the helper and a side transport, with the dog off leash, to the judge over a distance of about 20 paces. A command for heeling or transport is allowed. The dog has to stay between helper and the handler. The dog must be attentive to the helper during transport. However, he is not allowed to press, jump or grip the helper. At the end of the transport, the handler takes a basic position in front of the judge, hands the padded stick to the judge and reports that protection is complete. The handler must free heel 5 paces away from the judge before taking a basic position and putting the leash on. The handler goes with his dog on leash, at the direction of the judge, under control to the position for the critique.

According to the information received on July 04th, 2019 the following applies in terms of the side transport:
If the dog attacks the helper during the side transport the handler has the chance to give a one-time command to release the helper again and to return the dog into the respective position for the side transport. A failure results in a disqualification.

Evaluation criteria

Egon Gutknecht

[Zurück](#)[Dashboard](#)

The dog is not reacting with a firm, fast, energetic and powerful engagement and/or effective prevention of the attack. Not quiet, calm and/or full on the grip until the release, not attentive, dominant or bumping during guarding of the helper are deducted accordingly.



IGP-ZTP

[Zurück](#)

[Dashboard](#)

The exercises in Phases A and B are based on the general regulations.
Phase C shall be carried out as follows:

IGP-ZTP		
The exercises in Phases A and B are based on the general regulations.		
Phase C shall be carried out as follows:		
Exercise 1 : Hold and Bark	15	Points
Exercise 2 : Advance and attack on the Handler HF	10/30	Points
Exercise 3 : Attack on the handler and his dog	40	Points
Exercise 4 : Transport to the Judge	5	Points
Total:	100	Points

General information

Egon Gutknecht

[Zurück](#)[Dashboard](#)

Only stick hits on shoulders and the area of the withers are allowed. The dog may only grip the protective sleeve on the Helper HL.

Hold and Bark

Egon Gutknecht

[Zurück](#)[Dashboard](#)

Stellen und Verbellen - 15 Punkte — 15

Points - Command e.g. „search“ or „forward“

The helper is located about 20 paces away from the handler and his dog, not visible to the dog, in a blind. At the direction of the judge, the handler unleashes his dog and sends him with a command to search and / or raise the arm and point to the blind.

The dog must actively, attentively, and persistently bark at the helper. The dog is not allowed to touch or grip the helper. The handler immediately goes to the dog at the direction of the judge and holds him on the collar. After the helper leaves the blind, the dog is leashed and taken into the blind in the basic position.



Heeling and attack on the Handler HF

[Zurück](#)[Dashboard](#)

Heeling 10 points - attack 30 points - Commands "heel" or "transport", "move" or "forward", "out", "sit"

At the direction of the judge the handler goes to the marked position 30 paces before the blind and removes the dog's leash. The leash is to be put away. At the direction of the judge the handler heels with his dog off leash in the direction of the blind. The dog must heel. At the direction of the judge the helper makes an attack with verbal threats on the handler and dog, when the handler and the dog are 10 paces before the blind. The dog must immediately, confidently and energetically attack with a full calm confident powerful grip. When the dog is on the sleeve, he receives 2 stick hits from the helper with a padded stick.

During the command for outing, the handler must stand still, without affecting the dog. At the direction of the judge the handler goes directly to the dog in normal gait, and returns him to the basic position with the command to sit.

The dog is held on the collar, but can not be stimulated by the dog handler. At the direction of the judge the helper goes away in a normal pace from the handler and dog. After about 40 paces, the helper turns to the handler and attacks the handler and his dog frontally with yelling and violent threatening movements. On the instructions of the judge, the handler HF will release his dog at a distance of about 30 paces with the command to "go". The dog has to defend the attack without hesitation by energetic and powerful attack. He may only attack the helper's protective sleeve. The dog handler is not allowed to leave his place. At the direction of the judge the helper stops. After the helper stops, the dog must immediately release. The dog handler can give a command to "release" in an appropriate time independently.

During the verbal command to "out" the handler must stand still without influencing the dog. After the release, the dog must remain close to the helper and guard intensely and powerful. At the direction of the judge the handler directly to his dog in a normal pace and returns him to the basic position with the command to sit. The handler puts the leash on his dog.



Transport to the Judge (LR)

[Zurück](#)[Dashboard](#)

100 Punkte

5 Points - Commands HZ „Heel“ or „Transport“

Then follows a side transport of the helper to the judge over a distance of about 10 paces. A command HZ "heel" or "transport" is allowed. The dog has to go to the right side of the helper so that the dog is between the helper and the dog handler. The dog must be attentive to the helper during transport. However, he is not allowed to press, jump or grip the helper. At the end of the transport, the handler takes a basic position in front of the judge, and reports that protection is complete.

IGP-V



[Zurück](#)

[Dashboard](#)

The IGP-V (Pre-IGP-1 test) has been developed by the Commission for FCI. This test can be used:

1. as prerequisite for admission in the working class.
2. as a prerequisite for admission to IGP-1, each National organization LAO can decide for themselves whether to require this test in their country. On the day of the examination, the dog must have reached the minimum required age. No exceptions may be made. Prerequisite for the entering is a successful BH / VT according to the national rules of the national organization.

Phase A	100	Points
Phase B	100	Points
Phase C	100	Points
Total:	300	Points

Conditions

Egon Gutknecht

[Zurück](#)[Dashboard](#)**Conditions**

The exercises in Phases A and B are based on the general regulations.

Phase C shall be carried out as follows:

Exercise 1 : Hold and Bark	15	Points
Exercise 2 : Prevention of Attempted Escape	30	Points
Exercise 3 : Attack on the Handler HF and his dog	50	Points
Exercise 4 : Transport to the judge LR	5	Points
Total	100	Points

According to the information received on July 04, 2019 the new examination regulations do not address the course respectively evaluation of the exercise “Jump over a Hurdle (80 cm)”. The committee for training and trial agreed to proceed in accordance with the previous FCI examination regulations (description of the course of the IPOVO) until further notice.

Prerequisite

Egon Gutknecht

[Zurück](#)[Dashboard](#)

On the day of the examination, the dog must have reached the minimum required age. No exceptions may be made. Prerequisite for the entering is a successful BH / VT according to the national rules of the national organization.

General provisions

Egon Gutknecht



[Zurück](#)

[Dashboard](#)

There is no TSB evaluation. The helper uses a padded stick to threaten the dog, but without striking.

Hold and Bark

Egon Gutknecht



[Zurück](#)

[Dashboard](#)

15 points – Commands "search"

The helper is located about 20 steps away from the handler and his dog, not visible to the dog, in a blind. At the direction of the judge, the handler unleashes his dog and sends him with a command to search and / or raise the arm and point to the blind. The dog must actively, attentively, and persistently bark at the helper. The dog is not allowed to touch or grip the helper. The handler immediately goes to the dog at the direction of the judge and holds him on the collar.



Prevention of Attempted Escape

[Zurück](#)[Dashboard](#)

30 Points –Command "out"

While the handler is holding his dog by the collar, the helper steps out of the blind and makes an escape attempt. On the order of the judge, the dog handler releases his dog. The dog must without hesitation try to prevent the attempted escape with high determination, and by a explosive and powerful attack. From the lockup of the helper to the out, the transitional phase is about 1 sec. After a transitional phase, the dog must let go. The handler may give a command to out within an appropriate time.

During the command for the "out" the handler must stand still without influencing the dog. After the release, the dog must remain close to the helper and guard this carefully. At the judge's direction the handler goes directly to his dog and holds him by the collar.

.



Attack on the Handler and his dog

[Zurück](#)[Dashboard](#)

50 Points – Commands: "Heel", "Out", "Sit", "Heel or Transport"

The dog is held on the collar, but can not be stimulated by the dog handler. At the direction of the judge the helper goes away in a normal pace from the handler and dog. After about 20 paces, the helper turns to the handler and attacks the handler and his dog frontally with yelling and violent threatening movements. The handler HF will release his dog with the command to "go". The dog has to defend the attack without hesitation by energetic and powerful attack. He may only attack the helper's protective sleeve. The dog handler is not allowed to leave his place. At the direction of the judge the helper stops. After the helper stops, the dog must immediately release. The dog handler can give a command to "release" in an appropriate time independently.

During the command to "out" the handler must stand still without influencing the dog. After the release, the dog must remain close to the helper and guard him attentively. On the judge's direction, the handler goes directly at a normal pace, to his dog and takes him into the basic position with command to sit.



Transport to the judge (LR)

[Zurück](#)[Dashboard](#)

5 Points - commands as "Heel" or "Transport"

Then follows a side transport of the helper to the judge over a distance of about 10 paces. A command HZ "heel" or "transport" is allowed. The dog has to go to the right side of the helper so that the dog is between the helper and the dog handler. The dog must be attentive to the helper during transport. However, he is not allowed to press, jump or grip the helper. At the end of the transport, the handler takes a basic position in front of the judge, and reports that protection is complete.



Tracking 1 – 3 (FPr 1 – 3)

[Zurück](#)

[Dashboard](#)

The tracking examinations in levels 1 to 3 consist only of the "A" Phase of the corresponding examination Levels of IGP-1 to 3. They can be completed to supplement the trial entries if at least four participants in the divisions BH-VT / IGP or IFH start. It is up to the handler, at which stage his dog is presented.

A training title in the sense of the show requirements, the breeding regulations and the "Breed survey" will not be awarded.

Maximum Points	Excellent	Very Good	Good	Satisfactory	Insufficient
100	100 – 96	95 – 90	89 – 80	79 – 70	69 - 0

The tracking examinations do not need to be performed in the order 1 to 3.



Obedience 1 – 3 (UPr 1 – 3)

[Zurück](#)

[Dashboard](#)

The Obedience examinations in levels 1 to 3 consist only of the "B" Phase of the corresponding examination Levels of IGP-1 to 3. They can be completed to supplement the trial entries if at least four participants in the divisions BH- VT / IGP or IFH start. It is up to the handler, at which stage his dog is presented. A training title in the sense of the show requirements, the breeding regulations and the "Breed survey" will not be awarded.

Maximum Points	Excellent	Very Good	Good	Satisfactory	Insufficient
100	100 – 96	95 – 90	89 – 80	79 – 70	69 - 0

The Obedience examinations do not need to be performed in the order 1 to 3.



Protection 1 – 3 (SPr 1 – 3)

[Zurück](#)

[Dashboard](#)

The Protection examinations in levels 1 to 3 consist only of the "C" Phase of the corresponding examination Levels of IGP-1 to 3. They can be completed to supplement the trial entries if at least four participants in the divisions BH- VT / IGP or IFH start. It is up to the handler, at which stage his dog is presented. A training title in the sense of the show requirements, the breeding regulations and the "Breed survey" will not be awarded.

Note: Protection Only Trials (Only Phase C) are **not** permitted.

Maximum Points	Excellent	Very Good	Good	Satisfactory	Insufficient
100	100 – 96	95 – 90	89 – 80	79 – 70	69 - 0

The Protection examinations do not need to be performed in the order 1 to 3.



Working dog test GPr 1 bis Gpr 3 (GPr 1-3)

[Zurück](#)

[Dashboard](#)

Maximum Points 200

The GPr 1 - 3 examinations only consist of Phases B and C of the corresponding examination Levels of IGP 1 - 3. Track work is not shown during these examinations.

A training title in the sense of the show requirements, the breeding regulations and the "Breed survey" will not be awarded.

Maximum Points	Excellent	Very Good	Good	Satisfactory	Insufficient
200	200 – 192	191 – 180	179 – 160	159 – 140	139 - 0



Test levels for the Article Indication Test

[Zurück](#)[Dashboard](#)

The requirements are set at different levels and reflect the individual testing levels.

Level	Indication Area	Articles	Points	Execution Time
1	20 x 30 m	2 Handler Articles Size: 10 x 3 x 1 cm Material = same type permitted 1 article left, 1 article right	10 / 10	10 minutes
2	20 x 40 m	4 Stranger Articles Size: 10 x 3 x 1 cm Material = different 2 articles left, 2 articles right	5 / 5 / 5 / 5	12 minutes
3	30 x 50 m	5 Stranger Articles Size: 5 x 3 x 1 cm Material: Different Placed at discretion	4 / 4 / 4 / 4 / 4	15 minutes

General Requirements

Egon Gutknecht



[Zurück](#)

[Dashboard](#)

In order to take this Examination, the dog must be a minimum of 15 months old and has passed the FCI-BH/VT test or has passed a national BH/VT test.

The handler reports in with his name and his dog's name in a sportsmanlike manner and advises the judge which level of test he is undertaking. Thereafter, he goes with his dog on leash to the designated start position and assumes the basic position. The dog is taken off leash for the indication work. The handler must keep the leash with him. Any force or punishment is to be avoided. Slightly going out of the boundaries is not faulty. Spectators are to be a reasonable distance away from the indication field.



Type of area for the Indication Work

[Zurück](#)[Dashboard](#)

Terrain: all natural ground (grass, ploughed field, wooded area). Tree stumps are also permitted. (avoid any opportunity for visual indication, so avoid short grass or other similar areas.)

Prior to laying out the articles, the indication area should be crossed by people several times, so that no one track is indicated.

Markings may be placed around the indication area.

[Zurück](#)[Dashboard](#)

Material: Wood, leather, artificial leather, textile

Placed articles may not differentiate themselves in colour to the terrain and should not be visible. Handler and dog must remain out of sight while the articles are placed.

There is no waiting time to begin. The dog may begin to search immediately after the articles are placed.



Deploying the dog to locate

[Zurück](#)[Dashboard](#)

The imaginary centre line and the bordering sides of the indication area will be made known to the handler by the judge. At the beginning a short preparation of the dog to start working at the imaginary centre line of the indication area is permitted. The handler moves within the imaginary centre line. He may only leave this to retrieve the article. Thereafter the dog is restarted from the centre line to locate the remaining article(s). Both verbal and visual commands are permitted. The command “lost” may be supported with the “search” command. Locating the article(s) with a “high Nose” is not faulty. The indication area may be repeatedly searched.

Behaviour at the articles

Egon Gutknecht



[Zurück](#)

[Dashboard](#)

Articles must be convincingly indicated and may not be touched by the dog. The articles may be indicated by sitting, standing or lying down or in varying styles. A command to indicate is not permitted and leads to the article being evaluated as “not found”.

No commands are permitted to get the dog to indicate the articles. If the dog has indicated an article, the handler goes to his dog and shows the judge the article by raising it up, then he returns to the centre line and restarts his dog to continue the article indication work.

The lying down position for the articles is not stipulated. The located article must however be in the immediate area of the dog's front paws.

The handler always approaches his dog from the side and may not stand in front of the dog. Praising the dog after the article is shown is permitted.

After the dog has located the last article, he is placed on leash. Thereafter, the handler shows the article and reports out to the judge.



Rating

[Zurück](#)

[Dashboard](#)

The maximum number of points for StPr 1 – 3 is 100 points. A minimum of 70 points must be achieved.

The evaluation criteria for all 3 levels

- a) the dog's tenacity is 20 points
(Following the instructions/ hand signals of the handler)
- b) the dog's intensity of work is 20 points (determination and work ethic)
- c) Stamina 10 points
(Never stopping the detection drive until the article is found)
- d) Behaviour of the dog handler 9 points (Affecting the dog)
- e) Finding the articles 41 points
(Convincing, confident, steady indication)

Maximum Points	Excellent	Very Good	Good	Satisfactory	Insufficient
100	100 – 96	95 – 90	89 – 80	79 – 70	69 - 0

General Regulations

Egon Gutknecht



[Zurück](#)

[Dashboard](#)

The exercise starts with the basic position at the edge of the search field and ends with the dog/handler team checking out to the judge. The articles found by the dog are to be shown.

Positive criteria

Egon Gutknecht

[Zurück](#)[Dashboard](#)

Consistent, quiet and fluent working, quick release from the dog handler, immediate response to verbal commands, persistent and purposeful working of the dog, wide side impacts of the dog. Arbeiten des Hundes, weite Seitenschläge des Hundes.

Faulty is

Egon Gutknecht

[Zurück](#)[Dashboard](#)

Picking up an article by the dog. Objects which are displayed with strong handler help are considered not found. Touching the article 1 - 3 points deduction

Premature breaking indication position, 1 - 3 points deduction

Handler leaves the imaginary centre line 2 - 5 points deduction

Mice catching, urinating or defecating, etc. 4 - 8 points deduction Wondering,

work lacks intensity, focus or determination 4 - 8 points deduction

The work must be terminated after exceeding the predetermined running time. The points reached to that time are evaluated.

Other negative evaluation criteria are:

Restless behavior when searching, barking, handler help, extensive overshooting of the search area boundaries by the dog.

**Indication Area 1 - 3**[Zurück](#)[Dashboard](#)

Level	Indication Area	Articles	Points	Execution Time
1	20 x 30 m	2 Handler Articles Size: 10 x 3 x 1 cm Material = same type permitted 1 article left, 1 article right	10 / 10	10 minutes
2	20 x 40 m	4 Stranger Articles Size: 10 x 3 x 1 cm Material = different 2 articles left, 2 articles right	5 / 5 / 5 / 5	12 minutes
3	30 x 50 m	5 Stranger Articles Size: 5 x 3 x 1 cm Material: Different Placed at discretion	4 / 4 / 4 / 4 / 4	15 minutes

Purpose

Egon Gutknecht



[Zurück](#)

[Dashboard](#)

Purpose

The endurance test is intended to provide proof that the dog is capable of a physical effort, without considerable fatigue shown subsequently. The dog's structure and physical condition must be able to hold up throughout the requirements of the entire examination. The examination places increased demands on the body and internal organs, especially the heart and lungs. But also examines other properties, such as temperament and hardiness. The effortless management of the performance must be seen as proof of the physical health and the presence of the required drives.

Before the test starts, the identity of the dog must be verified.

The same provisions apply to the event approval as for the other examinations determined by the national organization. The result must be entered in the scorebook, or on the pedigree.

When applying for an event authorization, the organizer accepts the responsibility to carry out the endurance test during the summer months only in the early morning or late afternoon hours. The outside temperature should not exceed 22 degrees Celsius (72 F).

Participation in an endurance test is voluntary. Should the handler or his dog be injured in the course of an endurance test, neither the organizer nor the judge can be held liable.



Admission of dogs

[Zurück](#)[Dashboard](#)

The minimum required age is 16 months. A maximum of 20 dogs are allowed per day with one judge. If there are more than 20 dogs then a second judge must be used. For safety reasons, each handler is allowed to show only one dog. The dogs must be fully and well trained. Ill, weak, overheated, pregnant or nursing bitches must not be allowed to start. At the beginning of the examination, the handler checks in with the judge. The judge has to be sure the dog is in good shape. Dogs that appear to be tired or unhappy are to be excluded from participation. If a dog shows excessive fatigue symptoms or other impairments during the test, the dog has to terminate in the examination.

All decisions by the judge are not contestable.

On the occasion of the SV endurance test a minimum of four dogs and four handlers have to be registered for the examination. In case that an SV endurance test is scheduled directly following an examination at a local group that was admitted by the SV administration, no minimum requirements in terms of participating dogs and handlers is required. An endurance test examination may also be carried out on a regular week day. On the occasion of an examination hosted at a local group a maximum of 36 units is allowed for which also includes the participants of the endurance test that is scheduled to follow the examination.

Rating

Egon Gutknecht

[Zurück](#)[Dashboard](#)

Points and ratings are not awarded, only "Passed" or "Not passed".

Terrain

Egon Gutknecht

[Zurück](#)[Dashboard](#)

The Examination will be held on roads and paths of various possible surfaces. For example: asphalt or unpaved streets, grass or dirt paths.

Performance of endurance test

Egon Gutknecht



[Zurück](#)

[Dashboard](#)

The Examination is a distance of 20 kilometres (12.4 Miles) in length at a rate of 12 to 15 kilometres per hour (7.5 to 9.3 MPH).

Running exercise

Egon Gutknecht



[Zurück](#)

[Dashboard](#)

The handler takes his dog to the starting position for the examination. The dog has to run (according to the traffic regulations) on the right side of the handler in a normal trot beside the bike. Avoid having the dog run too fast. The leash must be kept longer so that the dog has the possibility to adapt to any tempo. Connection devices ("Springer") are allowed. Slight pulling on the leash is not faulty, but the dog should not be constantly dragging and choking himself. After the first 8 km (5 miles), a break of 15 minutes is required. During this time the Judge must watch the dog for any signs of fatigue. Fatigued Dogs shall be terminated from the examination. After the break, 7 km (4.5 miles) more are to be covered, then a break of 20 minutes. During this break, the dog is given the opportunity to move freely and without constraint.

Shortly before the return to the final running portion the judge must check the dogs for fatigue or injury to their paws. Fatigued dogs or dogs whose paws are injured must be terminated. After completion of the final running portion, a 15 minute break must be inserted. During the break, the dog must be given the opportunity to move freely and without constraint. The judge must determine whether the dog shows signs of fatigue or injury to the paws.

Judges should accompany the dogs on the bike if possible, if not they should follow in a car. The results must be entered in the scorebook. It is necessary for the handler/dogs to be accompanied by a motor vehicle so that dogs that cannot continue, can be loaded into the motor vehicle and transported back to the start.

Dogs that show exceptional signs of fatigue or are unable to withstand the minimum speed of 12 km/h can not pass the examination.

Purpose

Egon Gutknecht



[Zurück](#)

[Dashboard](#)

Purpose

The endurance test is intended to provide proof that the dog is capable of a physical effort, without considerable fatigue shown subsequently. The dog's structure and physical condition must be able to hold up throughout the requirements of the entire examination. The examination places increased demands on the body and internal organs, especially the heart and lungs. But also examines other properties, such as temperament and hardiness. The effortless management of the performance must be seen as proof of the physical health and the presence of the required drives.

Before the test starts, the identity of the dog must be verified.

The same provisions apply to the event approval as for the other examinations determined by the national organization. The result must be entered in the scorebook, or on the pedigree.

When applying for an event authorization, the organizer accepts the responsibility to carry out the endurance test during the summer months only in the early morning or late afternoon hours. The outside temperature should not exceed 22 degrees Celsius (72 F).

Participation in an endurance test is voluntary. Should the handler or his dog be injured in the course of an endurance test, neither the organizer nor the judge can be held liable.

Admission of dogs

Egon Gutknecht



[Zurück](#)

[Dashboard](#)

The minimum required age is 16 months. A maximum of 20 dogs are allowed per day with one judge. If there are more than 20 dogs then a second judge must be used. For safety reasons, each handler is allowed to show only one dog. The dogs must be fully and well trained. Ill, weak, overheated, pregnant or nursing bitches must not be allowed to start. At the beginning of the examination, the handler checks in with the judge. The judge has to be sure the dog is in good shape. Dogs that appear to be tired or unhappy are to be excluded from participation. If a dog shows excessive fatigue symptoms or other impairments during the test, the dog has to terminate in the examination.

All decisions by the judge are not contestable.

In addition to the regulations as laid down in the IGP (International Utility Dogs Regulations) the SV allows for a soft collar respectively leather collar as well as for a harness on the occasion of an endurance test (resolution taken on the occasion of the SV GAM 2019)



Rating

[Zurück](#)

[Dashboard](#)

Points and ratings are not awarded, only "Passed" or "Not passed".

Terrain

Egon Gutknecht

[Zurück](#)[Dashboard](#)

The Examination will be held on roads and paths of various possible surfaces. For example: asphalt or unpaved streets, grass or dirt paths.



Performance of endurance test

[Zurück](#)[Dashboard](#)

Performance of endurance test:

The Examination is a distance of 20 kilometres (12.4 Miles) in length at a rate of 12 to 15 kilometres per hour (7.5 to 9.3 MPH).

Running exercise

Running exercise

Egon Gutknecht



[Zurück](#)

[Dashboard](#)

Running exercise

The handler takes his dog to the starting position for the examination. The dog has to run (according to the traffic regulations) on the right side of the handler in a normal trot beside the bike. Avoid having the dog run too fast. The leash must be kept longer so that the dog has the possibility to adapt to any tempo. Connection devices ("Springer") are allowed. Slight pulling on the leash is not faulty, but the dog should not be constantly dragging and choking himself. After the first 8 km (5 miles), a break of 15 minutes is required. During this time the Judge must watch the dog for any signs of fatigue. Fatigued Dogs shall be terminated from the examination.

After the break, 7 km (4.5 miles) more are to be covered, then a break of 20 minutes. During this break, the dog is given the opportunity to move freely and without constraint.

Shortly before the return to the final running portion the judge must check the dogs for fatigue or injury to their paws. Fatigued dogs or dogs whose paws are injured must be terminated. After completion of the final running portion, a 15 minute break must be inserted. During the break, the dog must be given the opportunity to move freely and without constraint. The judge must determine whether the dog shows signs of fatigue or injury to the paws.

Judges should accompany the dogs on the bike if possible, if not they should follow in a car. The results must be entered in the scorebook. It is necessary for the handler/dogs to be accompanied by a motor vehicle so that dogs that cannot continue, can be loaded into the motor vehicle and transported back to the start.

Dogs that show exceptional signs of fatigue or are unable to withstand the minimum speed of 12 km/h can not pass the examination.



Track shapes IGP-1 and IGP-2

[Zurück](#)[Dashboard](#)

The tracking sketches are examples and can also be placed in mirror image.

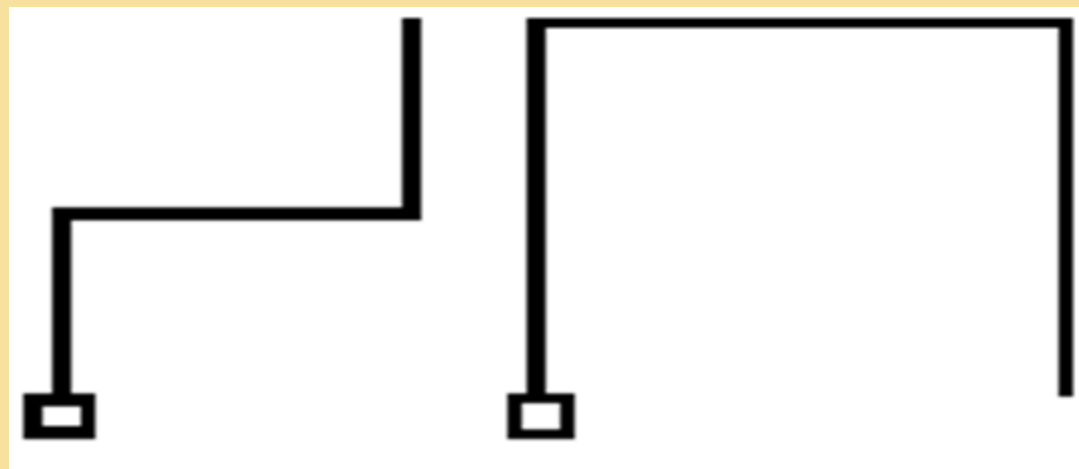



Track shapes IGP- 3

Zurück

Dashboard

The tracking sketches are examples and can also be placed in mirror image.

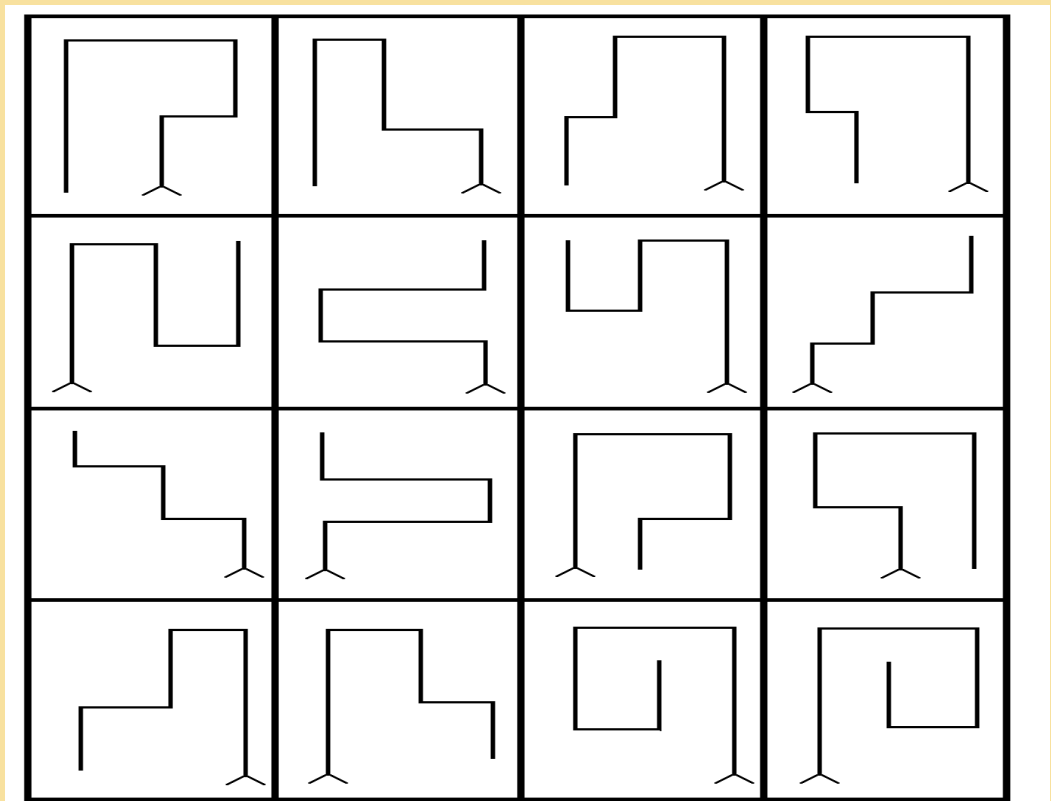



Track shapes IFH-V

Zurück

Dashboard

Possible tracks for IFH-V

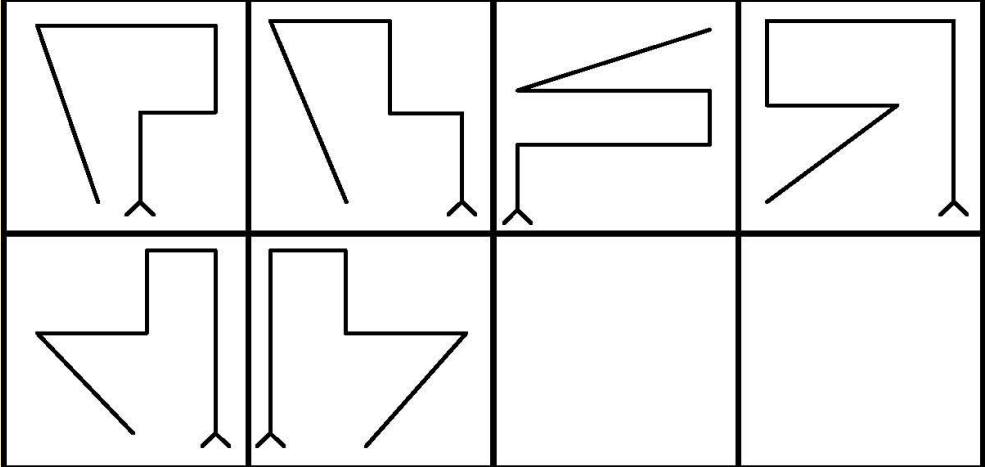



Track shapes IFH-1

Zurück

Dashboard

Possible tracks for IFH-1

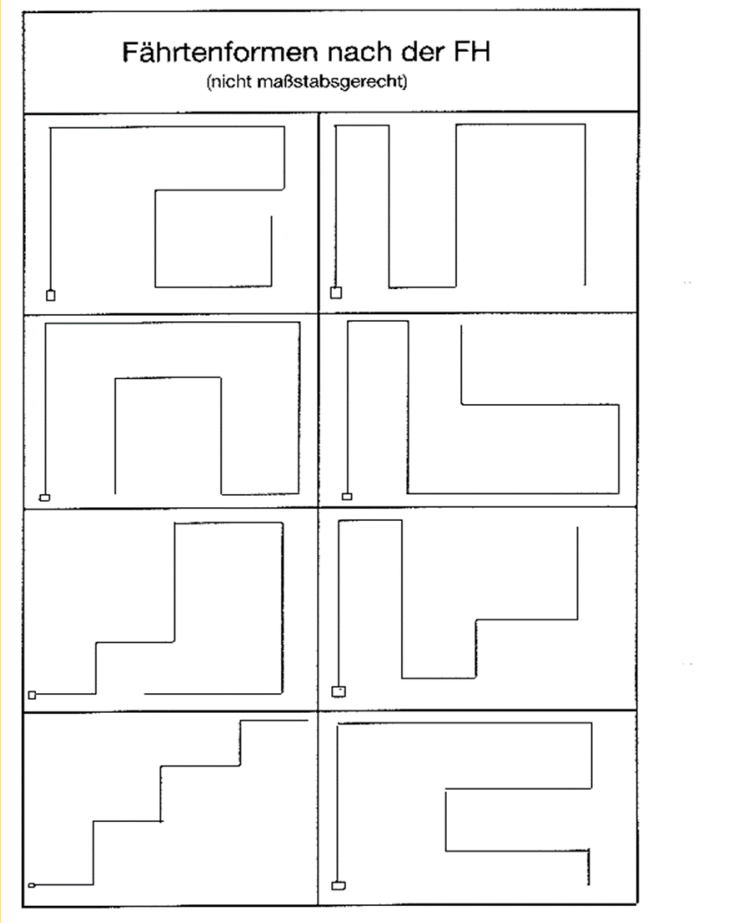



Track shapes IFH-2 und IGP-FH

Zurück

Dashboard

IFH-2 und IGP-FH; Possible tracks

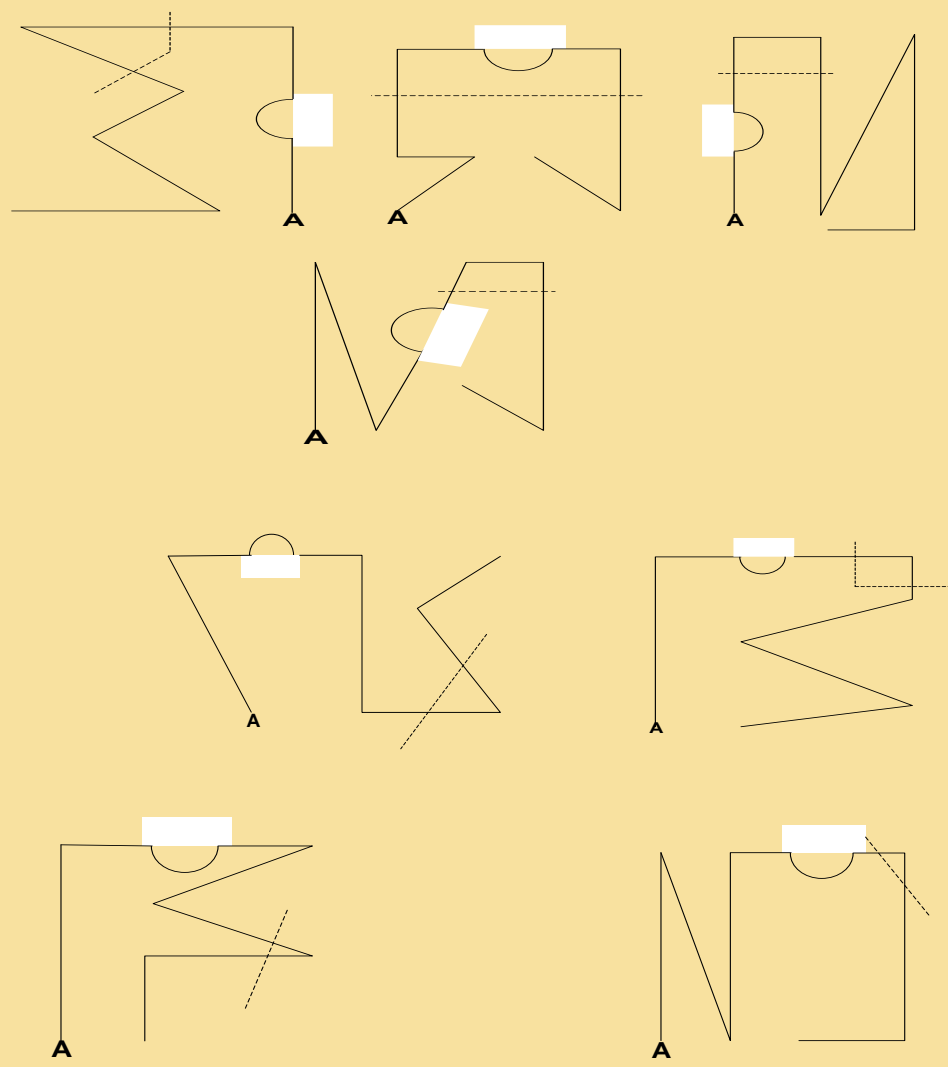



Corner

Zurück

Dashboard

Corner





Laying the article

[Zurück](#)[Dashboard](#)

Laying the article



alternative way of laying the article



According to the information received on July 04, 2019 in the sketch showing the laying of the objects it is evident that the object is supposed to be placed between two tracks. However, it is not mandatory to lay the objects in this fashion. The objects may also be placed on the individual tracks.

Sharp angle



Zurück

Dashboard

Sharp angle

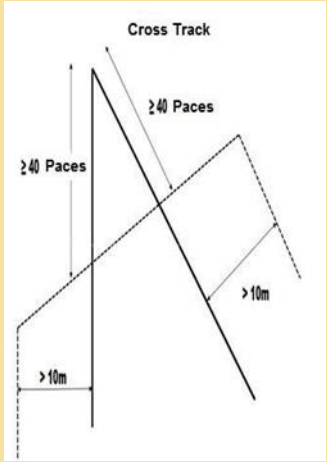
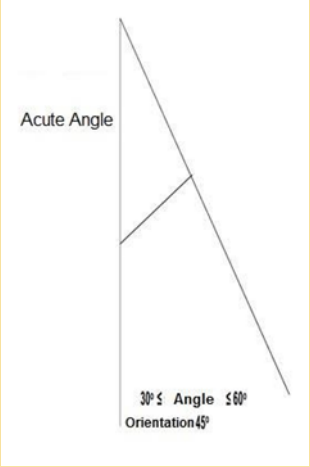
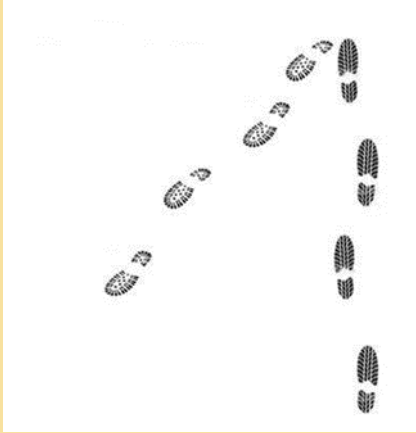



Blind Search

Zurück

Dashboard

Blind Search

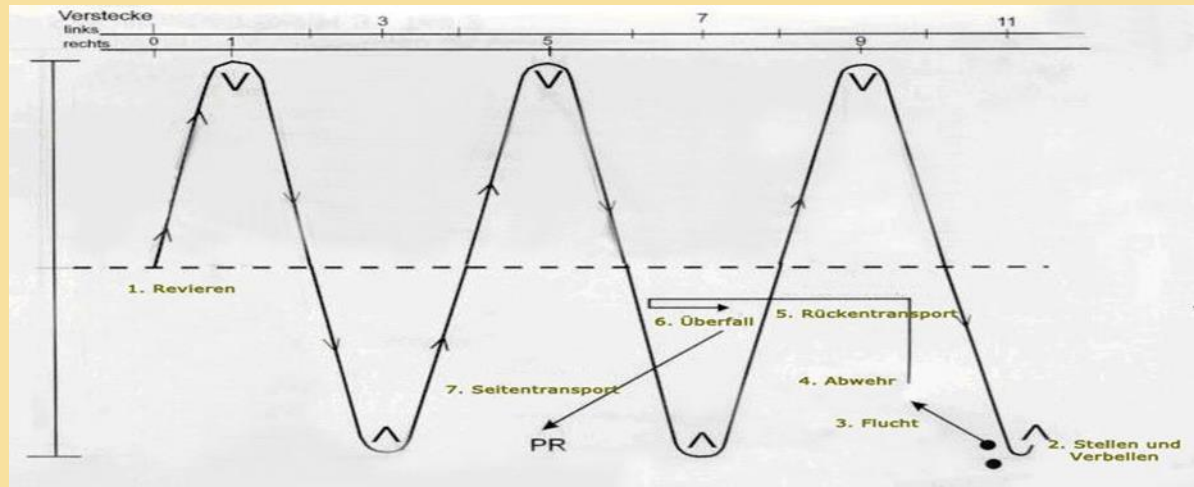



Setup for Prevention of an Escape

[Zurück](#)[Dashboard](#)

Setup for Prevention of an Escape

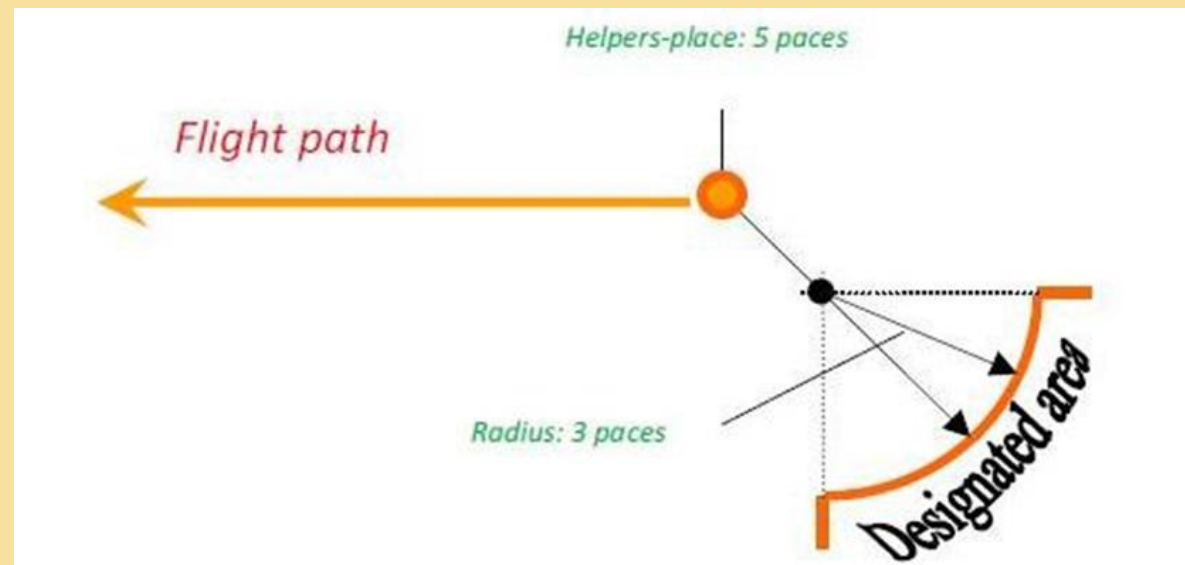



Hurdle

Zurück

Dashboard

Hurdle:

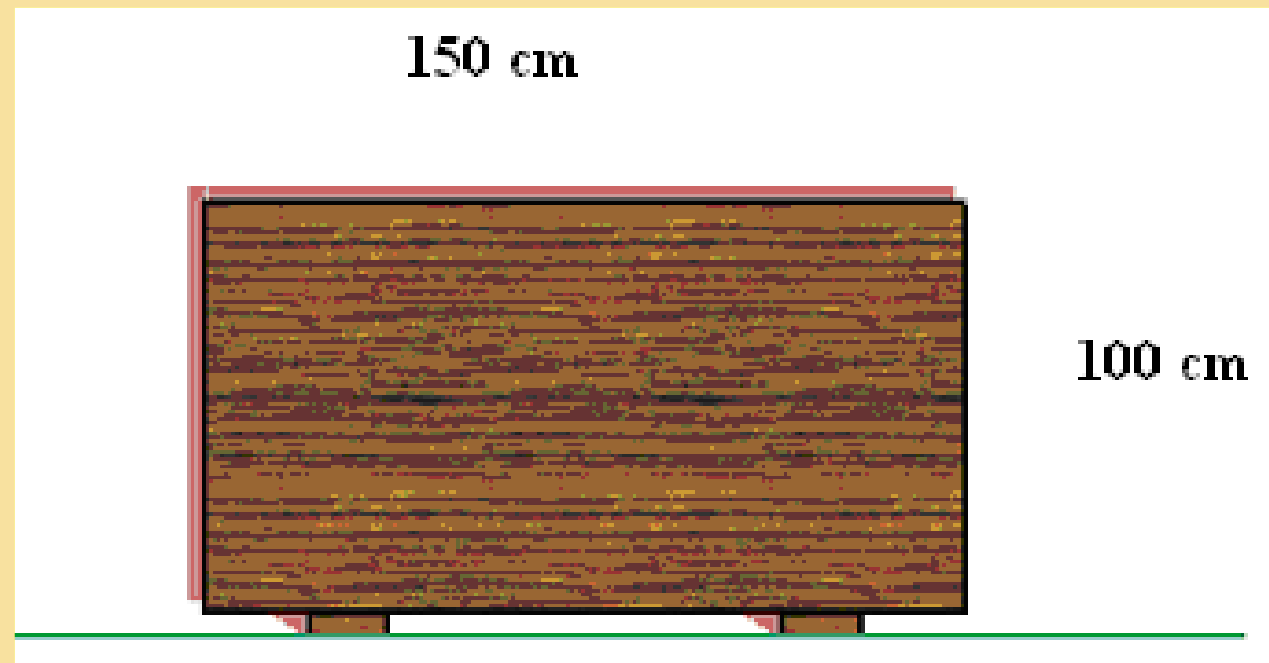



Scaling wall

Zurück

Dashboard

The scaling wall consists of 2 sides joined at the top and must be 150 cm wide and 190cm high. At the bottom both sides stand apart so that there is a peak height of 180cm The entire area of the scaling wall must be covered with anti skid material. At the upper part of the sides 3 cleats 24/48mm must be fixed. All dogs must jump the same obstacles.

Test jumps are not permitted during the Examination.

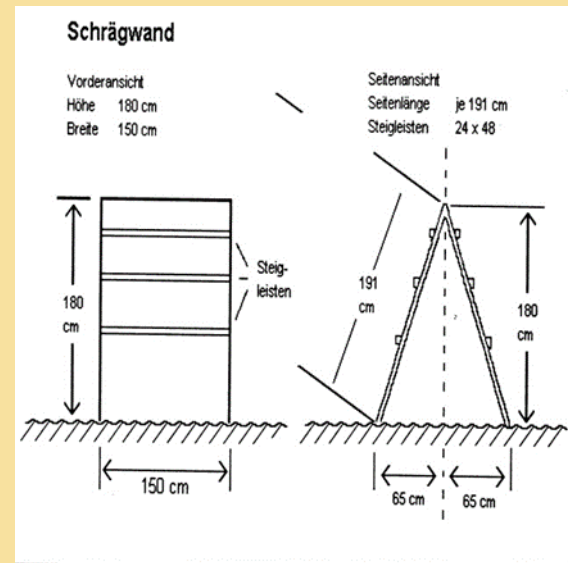

Dumbbells



[Zurück](#)

[Dashboard](#)

	IGP-1	IGP-2	IGP-3
On the flat	650 gr	1.000 gr	2.000 gr
Jump	650 gr	650 gr	650 gr
Scaling wall	650 gr	650 gr	650 gr

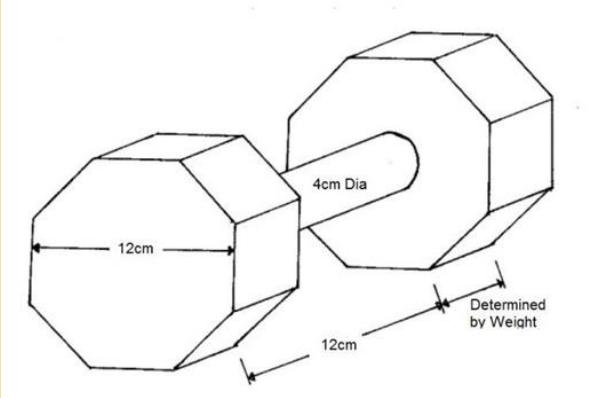

For the retrieve exercises only dumbbells are allowed. The dumbbells provided by the hosting club/ organizer must be used by all participants. Dog Handler's own dumbbells are not permitted except in IBGH-2 and IBGH-3. The sketch of the Dumbbell above is merely a sample. It is important that the weights are correct and that the bars are made of wood and that the bars are at least 4 cm from the ground.

Präambel des SV

Egon Gutknecht



[Zurück](#)

[Dashboard](#)

Der nachstehende Leitfaden der Federation Cynologique Internationale (FCI) und des Verbandes für das Deutsche Hundewesen für Internationale Gebrauchshundeprüfungen und Fährtenhundeprüfungen hat Weisungscharakter für alle Leistungsveranstaltungen innerhalb der FCI und des VDH.

Es ist jedoch darauf hinzuweisen, dass die jeweiligen prüfungsberechtigten Mitgliedsvereine und -verbände berechtigt sind, entsprechend ihren vereinseigenen Bestimmungen Zusatzregeln aufzunehmen. Nachstehende Regeln sind deshalb zu beachten:

Leistungsrichter Kostenabrechnung

Egon Gutknecht



[Zurück](#)

[Dashboard](#)

1. LEISTUNGSRICHTER 1.1. KOSTENABRECHNUNG

Fahrtkosten des LR können nur zwischen dem Wohnort und dem Ort der Veranstaltung berechnet werden. Ein aus persönlichen Verhältnissen des LR entstandener Umweg ist dem Veranstalter nicht zu berechnen. Die Höhe der jeweils zu erstattenden Kosten ergibt sich aus den vom Hauptverein festgelegten Beträgen.

LEISTUNGSRICHTER / HÖCHSTGRENZE PRÜFUNGEN

Egon Gutknecht



[Zurück](#)

[Dashboard](#)

1.2. HÖCHSTGRENZE PRÜFUNGEN

Pro Leistungsrichter dürfen im Kalenderjahr 30 Prüfungen abgenommen werden, wobei Prüfungen im Ausland, Landesgruppen-Prüfungen und die Bundessiegerprüfung hiervon ausgenommen sind.

Ein Leistungsrichter darf in einer Saison in einer Ortsgruppe nur einmal richten. Dies gilt auch bei reinen BH-Prüfungen.

RICHTEN IN DER EIGENEN ORTSGRUPPE

Egon Gutknecht



[Zurück](#)

[Dashboard](#)

1.3. RICHTEN IN DER EIGENEN ORTSGRUPPE

Ein Richter darf in seiner eigenen Ortsgruppe nur nachstehende Prüfungen abnehmen: GPr 1-3, FPr 1-3, UPr 1-3, SPr 1-3, StPr 1-3, RH1, IBGH 1-3.

AUSFALL EINER VERANSTALTUNG/ REDUZIERUNG DER PRÜFUNGSTAGE

Egon Gutknecht



[Zurück](#)

[Dashboard](#)

2. AUSFALL EINER VERANSTALTUNG/REDUZIERUNG DER PRÜFUNGSTAGE

Fällt eine termingeschützte Veranstaltung aus Gründen aus, die der Veranstalter zu vertreten hat (z. B. keine Meldungen), ist der Hauptverein sowie der LR vom PL bis spätestens Donnerstagmittag 12:00 Uhr zu informieren.

Gleiches gilt für die Reduzierung der Prüfungstage aufgrund geringer Teilnehmerzahl. Bei Reduzierung der Prüfungstage bzw. Absage der Prüfung nach diesem Zeitpunkt ist immer der Vereinsausbildungswart unter der im Verzeichnis der Amtsträger angegebenen Mobilnummer durch den Prüfungsleiter zu informieren.

Sofern diese Benachrichtigung nicht erfolgt, gehen evtl. anfallende Kosten für eine möglicherweise beauftragte Prüfungsaufsicht zu Lasten der durchführenden Ortsgruppe. Bei Nichtbeachtung und Verdacht auf Prüfungsmanipulation behält sich der Hauptverein vor, eine Leistungsüberprüfung gemäß § 14 der Rechts- und Verfahrensordnung zu beantragen und die vergebenen Ausbildungskennzeichen ggf. abzuerkennen.

VORBEREITUNG DER PRÜFUNG / BEGINN DER PRÜFUNG FÄHRTENGELÄNDE

Egon Gutknecht



[Zurück](#)

[Dashboard](#)

3. VORBEREITUNG DER PRÜFUNG / BEGINN DER PRÜFUNG 3.1. FÄHRTENGELÄNDE

Das Fährtenengelände muss im Umfang und in der Beschaffenheit der Prüfungsordnung entsprechend sein. Um eine umfassende Beurteilung der gezeigten Leistungen zu ermöglichen, hat das Legen der Fährte im Beisein des LR zu erfolgen.

[Zurück](#)[Dashboard](#)

3.2. GERÄTE

Alle Geräte (Hürde, Kletterwand, Bringhölzer, Verstecke und Helferausstattung/-bekleidung etc.) müssen entsprechend der Prüfungsordnung bereit gestellt werden. Ohne ordnungsgemäße Bereitstellung kann eine Prüfung nicht abgenommen werden

BEGINN DER PRÜFUNG

Egon Gutknecht

[Zurück](#)[Dashboard](#)

3.3.

BEGINN DER PRÜFUNG**Der Prüfungsbeginn darf****in den Sommermonaten nicht vor****6:00 Uhr****in den Wintermonaten (Jan.-Apr. und Sept.-Dez.) nicht vor****7:00 Uhr****bei Freitagsprüfungen nicht vor 12:00 Uhr****gelegt werden. Hiervon ausgenommen sind überregionale Prüfungen.****Der Treffpunkt für LR und Prüfungsleiter ist zwingend am Vereinsheim der durchführenden Ortsgruppe.**

[Zurück](#)[Dashboard](#)

4. BEWERTUNGSLISTEN

Die Bewertungslisten sind binnen einer Woche durch den LR zur Hauptgeschäftsstelle und zum zuständigen Landesgruppen-Ausbildungswart zu senden.

**BEGLEITHUNDEPRÜFUNG MIT
VERHALTENSTEST (BH/VT)**

Egon Gutknecht

[Zurück](#)[Dashboard](#)**5. BEGLEITHUNDEPRÜFUNG MIT VERHALTENSTEST (BH/VT)**

Die Mindestteilnehmerzahl bei einer reinen BH-/VT-Prüfung ist auf 4 Hunde und mindestens 2 Hundeführer festgelegt. Die Festlegung der Mindestteilnehmerzahl von 4 Hundeführern im Allgemeinen Teil der Prüfungsordnung auf Seite 17 gilt nicht für reine BH-/VT-Prüfungen.

Die BH/VT mit Sachkundeprüfung

entspricht drei Abteilungen

Die BH/VT ohne Sachkundeprüfung

entspricht zwei Abteilungen

Jeder Hund, egal in welcher Prüfungsstufe dieser IGP er vorgeführt wird, hat zunächst eine BH/VT-Prüfung erfolgreich zu absolvieren (außer SVAD-Prüfung).

**MINDESTTEILNEHMERZAHL
PRÜFUNGSTEILNEHMER
MITGLIEDSCHAFT/DECKAKT**

Egon Gutknecht

[Zurück](#)[Dashboard](#)**MINDESTTEILNEHMERZAHL/PRÜFUNGSTEILNEHMER/
MITGLIEDSCHAFT**

Die Mindestteilnehmerzahl wird auf 4 Hundeführer mit 4 Hunden festgelegt, aus den Bereichen der IGP Prüfungsordnung und der SV-Prüfungen.

Für die Teilnahme an einer termingeschützten Veranstaltung ist eine gültige Mitgliedschaft der Eigentümer und Hundeführer der teilnehmenden Hunde in einem dem VDH, der FCI oder der WUSV angehörenden Verein/Verband Voraussetzung.

Eine Hündin darf ab dem 19. Tag nach dem Deckakt keine Prüfung der Sportart IGP, IFH, RH und Wasserarbeit ausüben. Dies gilt bis zur vollendeten 12. Woche nach dem Wurftag. Im Bereich Ausdauer darf ab dem Deckakt keine Belastung mehr stattfinden.

[Zurück](#)[Dashboard](#)

7. DH-PRÜFUNGEN

Diese werden nur anerkannt, wenn sie durch die jeweilige Behörde bestätigt sind (formlose Bescheinigung). Diese Bescheinigung ist der Hauptgeschäftsstelle vorzulegen, ob eine Anerkennung erfolgen kann:

DH-PO 1 als IGP 2

DH-PO 2 als IGP 3

Nach der Anerkennung der DH-PO 1 kann die IGP 3-Prüfung abgelegt werden, wenn das Zulassungsalter erreicht ist.

[Zurück](#)[Dashboard](#)

8. SVAD-PRÜFUNGEN

Ist mit der Prüfung eine SVAD geschützt, so ist es dem LR freigestellt, anschließend die SVAD abzunehmen. Eine Verpflichtung besteht jedoch nicht.

Bei der SVAD können auch solche Hunde vorgeführt werden, die an der Prüfung vorher teilgenommen haben.

[Zurück](#)[Dashboard](#)

9. SOZIALUNVERTRÄGLICHKEIT

Im Leitfaden der FCI für Gebrauchshundeprüfungen ist die Vorgehensweise bei sozialer Unverträglichkeit geregelt. In diesen Fällen erfolgt Disqualifikation und der Hundeführer erhält die Auflage, den Hund auf einer Begleithundeprüfung mit Verhaltenstest vorzustellen. Dem amtierenden Richter ist freigestellt, je nach Schwere des Falles, gleichzeitig eine Nachkommeneintragungssperre gemäß Ziffer 4.1.3. der SV-Zuchtordnung zu beantragen.

Bei Nichtbestehen dieser durch den Vereinsausbildungswart angeordneten Begleithundeprüfung besteht die Möglichkeit, diese noch einmal zu wiederholen. Besteht der Hund auch diese wiederholte Prüfung aufgrund von sozialer Unverträglichkeit nicht, wird ein dauerhaftes Veranstaltungsverbot für diesen Hund verhängt; gleichzeitig erfolgt eine Nachkommeneintragungssperre gemäß Ziffer 4.1.3. der SV-Zuchtordnung.

[Zurück](#)[Dashboard](#)

10. VIDEOAUFNAHMEN

Bei allen termingeschützten Veranstaltungen werden Videoaufnahmen als Beweismittel nicht zugelassen.

ÜBERREGIONALE VERANSTALTUNGEN

Egon Gutknecht



Zurück

Dashboard

11. ÜBERREGIONALE VERANSTALTUNGEN

Überregionale Veranstaltungen (z. B. Qualifikationen, Meisterschaften) unterliegen den Sonderregelungen des Hauptvereins.



Encounter with joggers or inline skaters

[Zurück](#)[Dashboard](#)

The dog handler walks along a quiet path with his dog. At least two joggers pass him without slowing down their speed. When the joggers have gone, joggers come back to the dog and dog handler and run past them without lowering their speed. The dog does not have to be in correct heel position, but he must not bother the passing joggers. It is permitted to have the handler place his dog in a sit or down position during the encounter. Instead of the joggers, one or two inline skaters can also pass and meet the dog instead.



Distribution and Point values of the exercises in the individual levels IBGH 1 - 3

Zurück

Dashboard

Exercise	IBGH-1	IBGH-2	IBGH-3
Heeling on Leash	30 Points	20 Points	
Free heeling	30 Points	20 Points	20 Points
Sit out of Motion	15 Points	15 Points	10 Points
Down out of Motion	15 Points	15 Points	10 Points
Stand while walking			10 Points
Retrieve on the Flat		10 Points	15 Points
Retrieve over the Scaling Wall (140 cm)			15 Points
Send Out with Down		10 Points	10 Points
Down under Distraction	10 Points	10 Points	10 Points
Total	100 Points	100 Points	100 Points



Specialties in IBGH 1 - 3

[Zurück](#)[Dashboard](#)

In all levels in which the dog is called by the dog handler to come and in all retrieve exercises, it is not obligatory for the dog to sit in front of the dog handler. The dog can go right away in the end- basic position. Before release the dumbbell there must be a pause of 3 sec, before the dog handler takes the dumbbell from the dog with the verbal command „out”.